

# AIR TREATMENT AND GAS GENERATION

Product Catalogue 2020

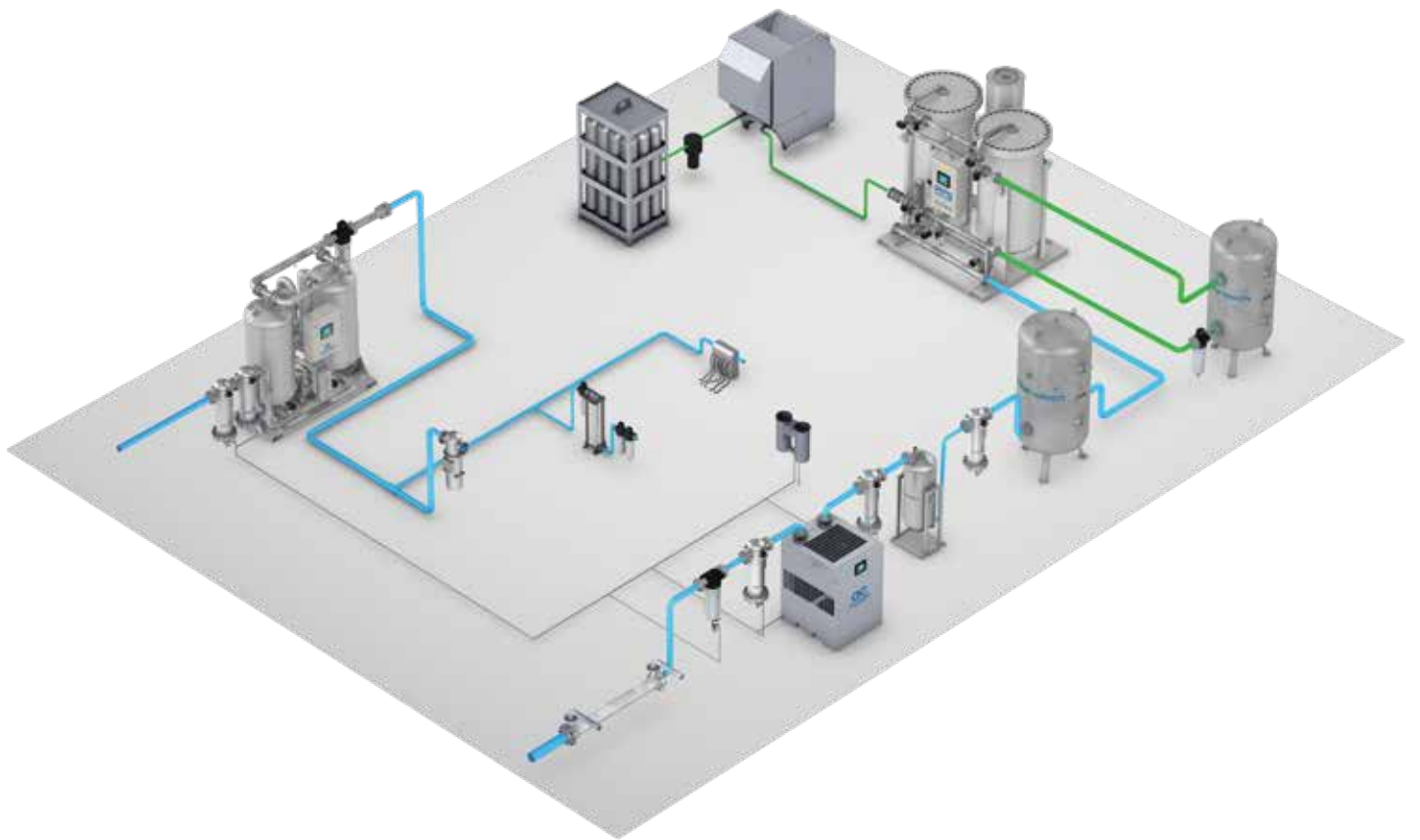

# Pneumatech Air Treatment



# Contents

## Adsorption Dryers ..... 7

PH 2 - 45 HE - Extruded profile heatless adsorption dryers .....	8
PH 55 - 550 HE - Extruded profile heatless adsorption dryers .....	10
PH 760-3390 HE - Welded vessel heatless adsorption dryers .....	12
PH 55 - 550 S - The cost-efficient alternative to PH 55-550 HE .....	14
PE 760 - 3390 S - Heated purge adsorption dryers.....	16
PB 210 - 635 HE (P/ZP) - Blower purge/ zero purge adsorption dryers .....	18
PB 700 - 6350 HE (P/ZP) - Blower purge/ zero purge adsorption dryers .....	20
PB 760 - 3390 S - The cost efficient alternative to PB 700-2950 HE .....	22

## Refrigeration Dryers ..... 25

Cool 12 - 272 - Non-cycling refrigeration dryers.....	26
AD 10 - 3000 - Non-cycling refrigeration dryers .....	28
AD 10 - 3000 - Non-cycling refrigeration dryers .....	30
Anti-corrosion treatment .....	31
AC 15 - 600 - Cycling refrigeration dryers .....	32
AC 650 - 2100 - Large cycling refrigeration dryers .....	34
AC 2650 - 8500 - Large cycling refrigeration dryers.....	36

## Membrane Dryers ..... 39

M POU 2 - 16 - Point-of-use membrane dryers.....	40
--	----

## Filter Solutions ..... 43

Ultimate water separators.....	44
Ultimate filters - Threaded filters.....	46
Ultimate filters - Elements.....	48
Ultimate filters - Industries.....	50
FF 1 - 12 - Flanged filters .....	52
VT - Activated carbon towers + vessels.....	54
H - High pressure filters.....	56
SLF - Silicone free filters .....	58
FP & FP HP - Process filters .....	60
FS - Sterile filters.....	62
TF DC - Filters with desiccant cartridges .....	64
TF CC & TF HC - Filters with activated carbon & hopcalite cartridges.....	65
BA 15 - 310 HE - Breathing air purifiers .....	66
BA 15 - 310 S - Breathing air purifiers.....	68
Competitor spare parts - Alternative line filter cartridges .....	70
Competitor spare parts - Alternative desiccants.....	72

## Condensate Management ..... 75

WD - Water detector .....	76
LD 100 - 204 - Zero loss drains .....	78
TD - Timer drain.....	80
MD - Mechanical zero-loss float drain .....	81
ECOBX 1 - Small oil water separator.....	82
ECOBX 2 - 4 - Oil water separators.....	84
OWS 75 - 5000 - Oil water separators.....	86
CA - Air cooled aftercoolers.....	88
CW 1 - 17 - Water cooled aftercoolers .....	90

## Gas Generators ..... 93

PPNG 6 - 68 HE - Nitrogen generator with pressure swing adsorption technology .....	94
PPNG 6 - 68 S - Nitrogen generator with pressure swing adsorption technology .....	96
PPNG SKID - High-pressure nitrogen skid.....	98
PPNG 150 - 800 HE - Nitrogen generators with pressure swing adsorption technology.....	100
PMNG 1-3 Nitrogen generator with membrane technology .....	102
PMNG 5 - 75 S - Nitrogen generator with membrane technology.....	104
PPOG 1 - 120 - Oxygen generator with pressure swing adsorption technology .....	106
Oxygen solutions .....	108

## Piping Systems ..... 111

AIRnet - Aluminium range .....	112
AIRnet - Stainless steel range .....	114

## Air Receivers ..... 117

V Range - Air & nitrogen receivers .....	118
V HP - Air & nitrogen receivers.....	120

## Compressed Air Purity ..... 123

For compressed air measurement equipment please email us on [support-eu@pneumatech.com](mailto:support-eu@pneumatech.com) for separate catalogue or visit our website [www.pneumatech.com](http://www.pneumatech.com)



# Compressed Air Treatment

Untreated compressed air always contains contaminants because of the nature of the gas and how it is produced. The need for air treatment basically results from 3 characteristics of compressed air.

## Compressed air is always wet

### Contaminants

- Liquid water - water aerosols - water vapor

### How are the contaminants formed?

As water is incompressible, the amount of moisture per  $\text{m}^3$  increases when air is compressed. The maximum amount of moisture per  $\text{m}^3$  air<sup>1</sup> is however limited for a certain temperature. Condensation will thus be formed when air is compressed.

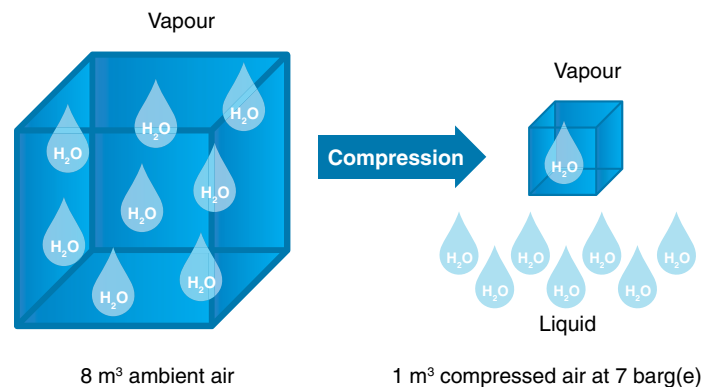

### What problems can the contaminants cause?

- Corrosion of pipe lines
- Bad quality of the end product
- Malfunctioning of controls
- Build-up of ice
- Cultivation of micro-organisms

## The Pneumatech solution

- Water separators
- Drains
- Refrigeration dryers
- Adsorption dryers

<sup>1</sup>The so-called holding capacity of moisture in air.

## Compressed air is always contaminated

### Contaminants

- Liquid oil - oil aerosols - oil vapor
- Dirt - microorganisms - pipescale
- Trace gases: carbon monoxide, sulfur dioxide, nitrous oxide

### How are the contaminants formed?

Added by the compressor installation through oil lubricated compressors (oil), adsorption dryers and activated carbon filters (dirt), piping network and vessels (pipescale).

Trash in, trash out: oil vapors from car exhausts and industrial processes, atmospheric dirt and microorganisms get sucked in by the compressor. As with water, their concentration – and thus importance – increases significantly after compression.

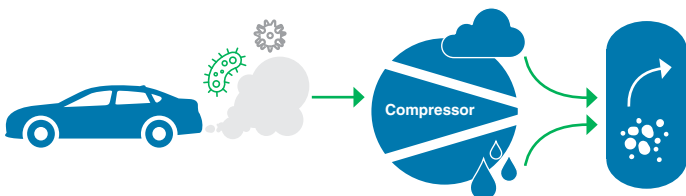

### What problems can the contaminants cause?

- Damaged production equipment, leading to inefficiencies and increased costs
- Air pollution, creating unhealthy work environments
- Pollution of the condensate

## The Pneumatech solution

- Coalescing filters for oil aerosols/particles
- Oil vapor filters
- Dust filters
- Oil-water separators
- Breathing air units

## Compressed air composes of other gases

### Contaminants

- Oxygen: contaminant if oxidation is unwanted
- Nitrogen: contaminant if oxidation is wanted

### How are the contaminants formed?

Dry air is mainly composed of nitrogen (78%) and oxygen (21%). Air will keep the same nitrogen/oxygen ratio after compression, so additional treatment is needed to change this gas mix.

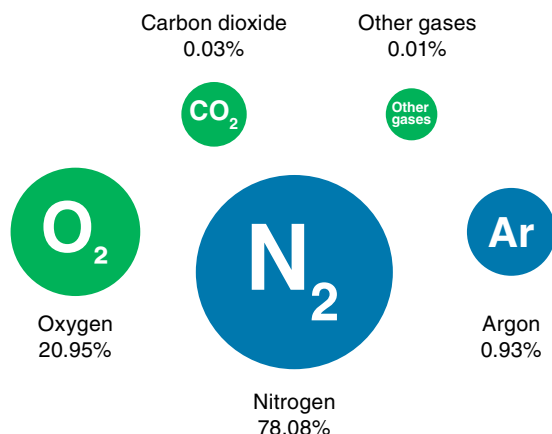

### What problems can the contaminants cause?

- Oxygen causes oxidation, leading to explosions or fire of flammables (fast oxidation) or to rotting processes and corrosion of metals (slow oxidation).
- Nitrogen is an inert gas that can prevent oxidation to happen.

## The Pneumatech solution

- PSA nitrogen generators
- Membrane nitrogen generators
- PSA oxygen generators

## **Optimal control & monitoring thanks to Pneumatech's Purelogic™ controller**

The Purelogic™ Central Controller is the ideal complement to your dryers and gas generators. This state-of-the-art control solution will provide optimal control and monitoring of your machines, increased reliability and reduced energy use.

The built-in web server allows direct read-out of all important parameters, settings and service counters of your dryer, by a simple connection via a local area network. Machine status information can also be received and dryers remotely start/stopped through voltage-free contacts. Communication with industrial protocols such as Modbus and Profibus is also possible.



# Adsorption Dryers

Pneumatech offers four different adsorption dryer technologies. Heatless dryers (PH) have the lowest initial investment cost, while zero-purge adsorption dryers (PB ZP) the lowest lifecycle cost. Heated purge (PE) and blower purge (PB) dryers balance between both.

No matter what your preference is, Pneumatech guarantees stable, dry air at the lowest operating costs and with excellent control and monitoring capabilities for each dryer you select.

## PH 2 - 45 HE - Extruded profile heatless adsorption dryers

### Features & Benefits

- ▶ Advanced energy management for lowest operating costs
  - Compressor synchronization
  - Purge nozzle optimization (optional)
  - PDP control (optional)
- ▶ High-quality, high-efficient desiccant, selected for the right application – molecular sieves
- ▶ Spring-loaded cartridges, hence minimizing the risk of crushed desiccant
- ▶ Counter-current regeneration for optimal energy efficiency and guaranteed dry air
- ▶ Designed for transportability & mountability
  - Dryer can be installed vertically or horizontally
  - Wall-mounting kit (optional)
- ▶ In & outlet can be reversed
- ▶ Low noise levels while purging
- ▶ High reliability and robust design

### General Specifications

- ▶ Heatless adsorption dryers: extruded profile design
- ▶ Dew points achievable: -40°C/-40°F & -70°C/-94°F
- ▶ Pressure range: 4-16 barg/58-232 psig
- ▶ Ambient temperature range: 1-50°C/34-122°F
- ▶ Inlet temperature range: 1-60°C/34-140°F
- ▶ Power supply: 230VAC 50/60Hz



### Options



Purge nozzle optimization



Wall mounting kit



PDP control





Incorporating high-quality components, PH heatless adsorption dryers provide you with clean, dry air to extend the life of your equipment and products. Heatless adsorption dryers use dry, expanded purge air to remove moisture from the desiccant material.

PH 2-45 HE adsorption dryers are capable of drying air to a PDP of  $-70^{\circ}\text{C}/-94^{\circ}\text{F}$ , simply by reducing the flow, thanks to the use of carefully selected molecular sieves. The desiccant is housed in a robust extruded aluminum body, which can operate until 16 barg/232 psig (fatigue load). The dryers are equipped with a mounted pre-filter and an integrated after-filter as standard,

can be installed vertically and can also be wall-mounted with a specially designed wall-mounting kit (optional).

The controller ensures the lowest operational costs thanks to compressor synchronization and the optional PDP control. LED's on the controller indicate whether power supply is connected, towers are pressurized and solenoids are functioning properly. It also provides with preventive maintenance information. Alarms can also be triggered remote thanks to the available voltage-free contact.

**Technical specifications for PH 2 HE up to PH 45 HE (standard version, PDP  $-40^{\circ}\text{C}$ )**

Specification	Unit	PH 2 HE	PH 4 HE	PH 6 HE	PH 11 HE	PH 15 HE	PH 20 HE	PH 25 HE	PH 35 HE	PH 45 HE
Nominal volume flow at dryer inlet <sup>(1)</sup>	l/s	1	2	3	5	7	10	12	17	22
	m <sup>3</sup> /hr	4	7	11	18	25	36	43	61	79
Average purge air consumption	%	18	18	18	18	18	18	18	18	18
Inlet and outlet connections	G	1/4"	1/4"	1/4"	1/2"	1/2"	1/2"	1/2"	1/2"	1/2"
	NPT	1/4"	1/4"	1/4"	1/2"	1/2"	1/2"	1/2"	1/2"	1/2"
Pressure drop at max. flow	barg	0.012	0.075	0.185	0.01	0.04	0.075	0.125	0.21	0.34
	psig	0.17	1.09	2.68	0.15	0.58	1.09	1.81	3.05	4.93
Included pre-filter size	Super fine filter	Mini 3 C HE	Mini 3 C HE	Mini 3 C HE	TF 1 C HE	TF 1 C HE	TF 1 C HE	TF 1 C HE	TF 1 C HE	TF 1 C HE
Mass	Kg	7	9	11	19	22	25	29	35	44
	Lb	15.5	19.8	24.2	41.9	48.5	55.1	63.9	77.1	97
Height	mm	540	720	855	640	725	875	1015	1270	1505
	inch	21.2	28.3	33.6	25.1	28.5	34.4	39.9	50	59.2
Width	mm	197	197	197	320	320	320	320	320	320
	inch	7.7	7.7	7.7	12.5	12.5	12.5	12.5	12.5	12.5
Length	mm	106	106	106	149	149	149	149	149	149
	inch	4.1	4.1	4.1	5.8	5.8	5.8	5.8	5.8	5.8

1. Flow is measured at reference conditions: 1 bara and 20°C at operating pressure of 7 barg, inlet temperature 35°C & std PDP of  $-40^{\circ}\text{C}$  at the outlet.

**Flow correction factors due to air inlet pressure Kp**

Operating pressure	barg	4	5	6	7	8	9	10	11	12	13	14	15	16
	psig	58	72	87	100	116	130	145	160	174	189	203	218	232
Pressure correction factor	Kp	0.62	0.75	0.87	1	1.12	1.25	1.37	1.5	1.62	1.75	1.87	2	2.12

**Flow correction factors due to air inlet temperature Kt**

Temperature	°C	20	25	30	35	40	45	50
	°F	68	77	86	95	104	113	122
Temperature correction factor	Kt	1.07	1.06	1.04	1	0.88	0.67	0.55

**Flow correction factors due to pressure dew point Kdp**

Dew point	°C	-40	-70
	°F	-40	-94
Dew point correction factor	Kdp	1	0.7

# PH 55 - 550 HE - Extruded profile heatless adsorption dryers

## Features & Benefits

- ▶ Advanced energy management for lowest operating costs
  - Compressor synchronization
  - Purge nozzle optimization
  - PDP control (optional)
- ▶ Best-in-class performance thanks to unique valve and exhaust design (patent pending)
  - Lowest pressure drop during drying
  - Lowest purge loss by ensuring maximum purge air expansion during regeneration
- ▶ Low noise levels during purge and blow-off
- ▶ High-quality, high-efficient desiccant, selected for the right application
  - PDP -20°C/-3°F & PDP -40°C/-40°F: activated alumina
  - PDP -70°C/-94°F: molecular sieves
- ▶ Spring-loaded desiccant, minimizing the risk of crushing
- ▶ Counter-current regeneration for optimal energy efficiency and guaranteed dry air
- ▶ Designed for transportability & mountability
  - Wall-mounting kit for PH 55-190 HE (optional)
- ▶ Optimal control and monitoring thanks to the Purelogic™ controller (optional)
- ▶ Desiccant bags for easy service from the top

## General Specifications

- ▶ Heatless adsorption dryers: extruded profile design
- ▶ Dew points achievable: -20°C/-3°F; -40°C/-40°F & -70°C/-94°F
- ▶ Pressure range: 4-14 barg/58-203 psig
- ▶ Ambient temperature range: 1-45°C/34-113°F
- ▶ Inlet temperature range: 1-50°C/34-122°F (For temperatures up to 60°C/140°F: see HIT option)
- ▶ Power supply: 230VAC 50/60Hz & 115VAC 50/60Hz



## Options

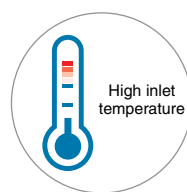

High inlet temperature

High inlet temperature

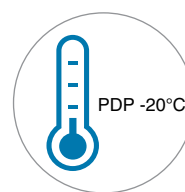

PDP -20°C

PDP -20°C

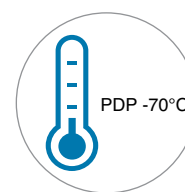

PDP -70°C

PDP -70°C



Wall mounting kit



PDP control



Purelogic controller



IP65 protection



Incorporating high-quality components, PH heatless adsorption dryers provide you with clean, dry air to extend the life of your equipment and products. Heatless adsorption dryers use dry, expanded purge air to remove moisture from the desiccant material.

PH 55-550 HE adsorption dryers are available in 3 PDP variants: -20°C/-4°F, -40°C/-40°F and -70°C/-94°F, each optimized to provide the lowest purge loss. The unique manifold (patent pending) includes pilot air controlled 3/2-way valves, which switch fast and reliably. The pressure drop over the valves is reduced to a minimum. This does not only result in a low pressure drop over the dryer, but also ensures maximum purge air expansion during regeneration. The latter makes that the purge consumption of the dryers has been reduced significantly.

The desiccant is spring-loaded and housed in a robust extruded aluminum body, which can operate up to 14 barg/203 psig (fatigue load). The dryers are equipped with a mounted pre-filter and after-filter as standard and can also be wall-mounted with a specially designed wall-mounting kit (optional).

Operating costs are optimized at all times thanks to the availability of compressor synchronization and purge nozzle optimization as standard and PDP control as option. The full machine status can be checked on the display of the controller and the vessel pressure gauges on the unit.

The controller indicates whether power supply is connected, towers are pressurized, valves are functioning properly or preventive maintenance needs to be done. In case the optional PDP control is connected, the PDP value can be monitored from the display. Alarms and warnings can also be triggered remote with the available voltage-free contacts.

Optionally the Purelogic™ can be used as central brain of the adsorption dryer.

The Purelogic™ offers impressive control and monitoring capabilities, and can communicate with industrial protocols as Modbus, Profibus or Ethernet/IP.

Technical specifications for PH 55 HE up to PH 550 HE (standard version, PDP -40 °C)												
Specification	Unit	PH 55 HE	PH 75 HE	PH 95 HE	PH 120 HE	PH 140 HE	PH 190 HE	PH 230 HE	PH 275 HE	PH 350 HE	PH 420 HE	PH 550 HE
Nominal volume flow at dryer inlet <sup>(1)</sup>	l/s	25	35	45	55	65	90	110	130	165	195	260
	m <sup>3</sup> /hr	90	126	162	198	234	324	396	468	594	702	936
Regeneration air consumption average at max. flow	%	16.5	16.5	16.5	16	16	16.5	16.5	16.5	16.5	17	17
Connection inlet/ outlet	G	1/2"	1"	1"	1"	1 1/2"	1 1/2"	1 1/2"	1 1/2"	1 1/2"	1 1/2"	2"
	NPT	1/2"	1"	1"	1"	1 1/2"	1 1/2"	1 1/2"	1 1/2"	1 1/2"	1 1/2"	2"
Pressure drop at max. flow	barg	0.031	0.065	0.114	0.18	0.278	0.114	0.18	0.278	0.18	0.278	0.278
	psig	0.45	0.94	1.65	2.61	4.03	1.65	2.61	4.03	2.61	4.03	4.03
Included pre & after filter size	Super fine filter	TF 3 C HE	TF 4 C HE	TF 5 C HE	TF 5 C HE	TF 6 C HE	TF 6 C HE	TF 6 C HE	TF 7 C HE	TF 8 C HE	TF 8 C HE	TF 9 C HE
	Dust filter	TF 3 S HE	TF 4 S HE	TF 5 S HE	TF 5 S HE	TF 6 S HE	TF 6 S HE	TF 6 S HE	TF 7 S HE	TF 8 S HE	TF 8 S HE	TF 9 S HE
Height	mm	1205	1205	1495	1495	1835	1495	1495	1835	1495	1835	1835
	inch	47.4	47.4	58.9	58.9	72.2	58.9	58.9	72.2	58.9	72.2	72.2
Width	mm	807	827	847	847	877	907	906	907	907	907	985
	inch	31.8	32.6	33.3	33.3	34.5	35.7	35.7	35.7	35.7	35.7	38.8
Length	mm	394	394	394	394	394	564	564	564	734	734	929
	inch	15.5	15.5	15.5	15.5	15.5	22.2	22.2	22.2	28.9	28.9	36.6
Mass	KG	100	109	128	140	165	217	234	276	331	389	500
	Lb	220.5	240.3	282.2	308.6	363.8	478.4	515.9	608.5	729.7	857.6	1102.3

\*1. Flow is measured at Reference Conditions: 1 bara and 20°C at operating pressure of 7 barg, inlet temperature 35°C & std PDP of -40°C at the outlet

Flow correction factors due to air inlet pressure												
Operating pressure	barg	4	5	6	7	8	9	10	11	12	13	14
	psig	58	72	87	100	116	130	145	160	174	189	203
Pressure correction factor	Kp	0.62	0.75	0.87	1	1.12	1.25	1.37	1.5	1.62	1.75	1.87

Flow correction factors due to air inlet temperature												
Temperature	°C	20	25	30	35	40	45	50				
	°F	68	77	86	95	104	113	122				
Temperature correction factor	Kt	1	1	1	1	0.84	0.67	0.55				

# PH 760 - 3390 HE - Welded vessel heatless adsorption dryers

## Features & Benefits

- ▶ Available in three standard variants
  - With Standard DC1 Controller (PDP Control optional)
  - With Purelogic™ (PDP control std available)
  - With Pneumatic Controller (no need of electricity for the installation and no PDP control possible)
- ▶ Lowest possible pressure drop thanks to innovative open silencer design
- ▶ Improved performance with reduced purge rate to 16% across the complete range
- ▶ Advanced energy management for lowest operating costs
  - PDP control - (std with Purelogic™ and optional with DC1 Controller)
  - Compressor synchronization
  - Purge nozzle optimization (optional)
- ▶ High-quality, high-efficient desiccant, selected for the right application
  - PDP -40°C/-40°F (std): activated alumina
  - PDP -70°C/-94°F and high inlet temp. (option): molecular sieves
- ▶ Minimal risk of crushed desiccant thanks to the large vessel diameter and the sonic nozzle (std available)
- ▶ Counter-current regeneration for optimal energy efficiency and guaranteed dry air
- ▶ High reliability and robust design
- ▶ Low noise levels while purging
- ▶ Designed for transportability
- ▶ Optimal control and monitoring thanks to the Purelogic™ controller

## General Specifications

- ▶ Heatless adsorption dryers: welded vessel design
- ▶ Dew points achievable: -40°C/-40°F & -70°C/-94°F
- ▶ Pressure range: 4-9 barg/58-130 psig (14 barg/203 psig variant available as separate variant)
- ▶ Ambient temperature range: 1-50°C/34-122°F
- ▶ Inlet temperature range: 1-55°C/34-131°F
- ▶ Power supply: 230VAC 50 Hz; 115VAC 60 Hz 3 ph



## Variants

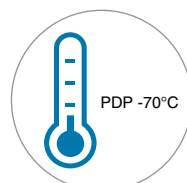

PDP -70°C

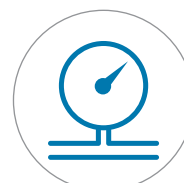

14.5 Bar(g)



DC1 controller

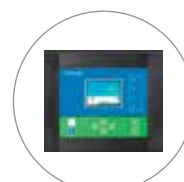

Purelogic™



Pneumatic controlled

## Options



Purge nozzle optimization



PDP Control for DC1 controller variants (std with Purelogic™ Controller)



In and outlet filters



Vessel Safety valves



Wooden Packaging

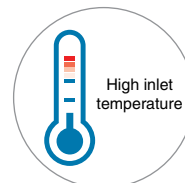

High inlet temperature

High inlet temperature



Pneumatech presents the newly designed and significantly improved heatless adsorption dryer range – PH 760-3390 HE. Incorporating high-quality components, PH heatless adsorption dryers provide you with clean, dry air to extend the life of your equipment and products. Heatless adsorption dryers use dry, expanded purge air to remove moisture from the desiccant material.

PH 760-3390 HE adsorption dryers are capable of drying air to a PDP of -40°C/-40°F as standard and -70°C/-94°F as option for higher flows up to 5760 m<sup>3</sup>/hr/3390 cfm. The desiccant is housed in welded vessels, which are coated and can operate up to 9 barg/130 psig (fatigue load) with std variant and up to 14,5 barg/203 psi with high pressure variant(fatigue load). All dryers can be equipped with 2 coalescing pre-filters before and 1 particulate filter after the dryer (optional).

Thanks to ingeniously designed mechanical components i.e open type of silencers and large vessels, PH 760-3390 HE range offers highest performance with lowest pressure drop and improved purge loss of 16%.

Considering different needs of the customers, the PH 760-3390 HE range offers 3 different controller for different requirements. DC 1 Controller version has a basic controller with required controls and monitoring such as Service Alarm, General alarm relay, synchronization control and optional dew point control whereas Purelogic™ controller version will have the Purelogic™ as central brain of the adsorption dryer. The Purelogic™ optimizes operating costs; ensures maximum reliability by monitoring the most important parameters; and offers impressive control and monitoring capabilities. For special applications where Pneumatic control is preferred and no electricity is possible, PH 760-3390 HE also operates with Pneumatically enabled controller.

Technical specifications for PH 760 HE up to PH 3390 HE (standard version, -40 PDP °C)							
Specification	Unit	PH760 HE	PH1020 HE	PH1330 HE	PH2060 HE	PH2670 HE	PH3390 HE
Max volume Flow at Dryer Inlet(1)	l/s	360	480	630	970	1260	1600
	m <sup>3</sup> /hr	5760	1728	2268	3492	4536	5760
Regeneration Air Consumption average at max. flow	%	16	16	16	16	16	16
Pressure Drop over Dryer excluding Filters	Bar	0.15	0.15	0.15	0.15	0.15	0.18
	PSI	2.18	2.18	2.18	2.18	2.18	2.61
Inlet and outlet connections	DIN PN16	DN80	DN80	DN80	DN100	DN100	DN150
Optional Pre & After Filter Sizes <sup>(2)</sup>	General purpose coalescing filter	PMH G 1529	PMH G 1529	G 1F	G 2F	G 3F	G 4F
	High efficiency coalescing filter	PMH C 1529	PMH C 1529	C 1F	C 2F	C 3F	C 4F
	Particulate filter	PMH S 1529	PMH S 1529	S 1F	S 2F	S 3F	S 4F
Length	mm	1776	1776	1884	2359	2472	2788
	inch	69.9	69.9	74.1	92.8	97.3	109.7
Width	mm	822	822	822	1000	1026	1417
	inch	32.3	32.3	32.3	39.3	40.3	55.7
Height	mm	2549	2549	2604	2671	2653	2576.5
	inch	100.3	100.3	102.5	105.1	104.4	101.4
Length	inch	69.9	69.9	74.2	92.9	97.3	109.8
Width	inch	32.4	32.4	32.4	39.4	40.4	55.8
Height	inch	100.4	100.4	102.5	105.2	104.4	101.4
Mass	kg	1220	1300	1620	2651	3100	4600
	lb	2690	2866	3571	5844	6834	10141

\*1. Flow is measured at Reference Conditions: 1 Bar(a) and 25°C at operating pressure of 7 bar (g), inlet temperature 35°C & std PDP of -40°C at the outlet

\*2. Filters are sized at reference conditions. Consult the AML of the filters for sizing outside the reference conditions.

**For accurate sizing for your operating conditions consult Pneumatech**

# PH 55 - 550 S - The cost-efficient alternative to PH 55-550 HE

## Features & Benefits

- ▶ Advanced energy management for lowest operating costs
  - Compressor synchronization
  - Purge nozzle optimization (2 nozzles)
  - PDP control (optional)
- ▶ High reliability and low maintenance costs thanks to unique valve design (patent pending)
- ▶ High-quality desiccant, resulting in a consistent PDP of  $-20^{\circ}\text{C}/-3^{\circ}\text{F}$  or  $-40^{\circ}\text{C}/-40^{\circ}\text{F}$
- ▶ Spring-loaded desiccant, minimizing the risk of crushing
- ▶ Counter-current regeneration for optimal energy efficiency and guaranteed dry air
- ▶ Designed for transportability & mountability
  - Wall-mounting kit for PH 55-140 S (optional)
- ▶ Advanced controller to monitor machine status at all times
- ▶ Desiccant bags for easy service from the top

## General Specifications

- ▶ Heatless adsorption dryers: extruded profile design
- ▶ Dew points achievable:  $-20^{\circ}\text{C}/-3^{\circ}\text{F}$  &  $-40^{\circ}\text{C}/-40^{\circ}\text{F}$
- ▶ Pressure range: 4-14 barg/58-203 psig
- ▶ Ambient temperature range:  $1-45^{\circ}\text{C}/34-113^{\circ}\text{F}$
- ▶ Inlet temperature range:  $1-50^{\circ}\text{C}/34-122^{\circ}\text{F}$
- ▶ Power supply: 230VAC 50/60Hz & 115VAC 50/60Hz



## Options



Wall mounting kit



PDP control



Incorporating high-quality components, PH heatless adsorption dryers provide you with clean, dry air to extend the life of your equipment and products. Heatless adsorption dryers use dry, expanded purge air to remove moisture from the desiccant material.

PH 55-550 S adsorption dryers are available in 2 PDP variants: -20°C/-4°F and -40°C/-40°F. The unique manifold (patent pending) includes pilot air controlled 3/2-way valves, which switch fast and reliably.

The desiccant is spring-loaded and housed in a robust extruded aluminum body, which can operate up to 14 barg/203 psig (fatigue load). Pre- and afterfilters are delivered as standard with every dryer.

Operating costs are optimized at all times thanks to the availability of compressor synchronization and purge nozzle optimization as standard and PDP control as option. The full machine status can be checked on the display of the controller and the vessel pressure gauges on the unit. The controller indicates whether power supply is connected, towers are pressurized, valves are functioning properly or preventive maintenance needs to be done. In case the optional PDP control is connected, the PDP value can be monitored from the display. Alarms and warnings can also be triggered remote with the available voltage-free contacts.

Technical specifications for PH 55 S up to PH 550 S (standard version, PDP -40 °C)												
Specification	Unit	PH 55 S	PH 75 S	PH 95 S	PH 120 S	PH 140 S	PH 190 S	PH 230 S	PH 275 S	PH 350 S	PH 420 S	PH 550 S
Nominal volume flow at dryer inlet	l/s	25	35	45	55	65	90	110	130	165	195	260
	m³/hr	90	126	162	198	234	324	396	468	594	702	936
Regeneration air consumption average at max. flow <sup>(1)(2)</sup>	%	18.5	18.5	18.5	18.5	18.5	18.5	18.5	18.5	18.5	18.5	18.5
Pressure drop at max. flow	barg	0.03	0.059	0.107	0.171	0.251	0.107	0.171	0.251	0.447	0.251	0.494
	psig	0.44	0.86	1.55	2.48	3.64	1.55	2.48	3.64	6.48	3.64	7.16
Connection inlet/outlet	G	1"	1"	1"	1"	1"	1 1/2"	1 1/2"	1 1/2"	1 1/2"	1 1/2"	1 1/2"
	NPT	1"	1"	1"	1"	1"	1 1/2"	1 1/2"	1 1/2"	1 1/2"	1 1/2"	1 1/2"
Integrated filter model	Super fine filter	TF 2 C S	TF 3 C S	TF 4 C S	TF 5 C S	TF 5 C S	TF 6 C S	TF 6 C S	TF 6 C S	TF 7 C S	TF 8 C S	TF 8 C S
	Dust filter	TF 2 S S	TF 3 S S	TF 4 S S	TF 5 S S	TF 5 S S	TF 6 S S	TF 6 S S	TF 6 S S	TF 7 S S	TF 8 S S	TF 8 S S
Height	mm	1070	1115	1285	1465	1615	1285	1465	1615	1695	1615	1915
	Inch	42.1	43.9	50.6	57.7	63.6	50.6	57.7	63.6	66.7	63.6	75.4
Width	mm	620	620	620	620	620	620	620	620	620	620	620
	Inch	24.4	24.4	24.4	24.4	24.4	24.4	24.4	24.4	24.4	24.4	24.4
Length	mm	401	401	401	401	401	571	571	571	571	738	738
	Inch	15.8	15.8	15.8	15.8	15.8	22.5	22.5	22.5	22.5	29.1	29.1
Mass	KG	87	88	99	114	124	165	197	211	245	298	328
	Lb	191.8	194.0	218.3	251.3	273.4	363.8	434.3	465.2	540.1	657.0	723.1

\*1. Flow is measured at reference conditions: 1 bara and 25°C at operating pressure of 7 barg, inlet temperature 35°C & std PDP of -40°C at the outlet.

Flow correction factors due to air inlet pressure Kp												
Operating pressure	barg	4	5	6	7	8	9	10	11	12	13	14
Pressure correction factor	Kp	0.62	0.75	0.87	1	1.12	1.25	1.37	1.5	1.62	1.75	1.87

Flow correction factors due to air inlet temperature Kt												
Temperature	°C	20	25	30	35	40	45	50				
Temperature correction factor	Kt	1	1	1	1	0.84	0.67	0.55				



# PE 760 - 3390 S - Heated purge adsorption dryers

## Features & Benefits

- ▶ Advanced energy management for lowest operating costs
  - Compressor synchronization
  - PDP control (optional)
  - Regeneration & cooling temperature control
- ▶ High-quality, high-efficient desiccant, selected for the right application
  - PDP -40°C/-40°F (std): Activated Alumina<sup>(1)</sup>
  - PDP -70°C/-94°F (option): Molecular sieves and Activated alumina
- ▶ Minimal risk of crushed desiccant thanks to the sonic nozzle and the large vessel diameter
- ▶ Counter-current regeneration for optimal energy efficiency and guaranteed dry air
- ▶ High reliability and robust design
- ▶ Low noise levels while purging
- ▶ Designed for transportability
- ▶ High efficient heaters, designed for maximum lifetime and minimal risk
- ▶ Optimal control and monitoring thanks to the Purelogic™ controller

## General Specifications

- ▶ Heated purge adsorption dryers: welded vessel design
- ▶ Dew points achievable: -40°C/-40°F & -70°C/-94°F
- ▶ Pressure range: 4-10 barg/58-145 psig
- ▶ Ambient temperature range: 1-40°C/34-104°F
- ▶ Inlet temperature range: 1-45°C/34-113°F
- ▶ Power supply: 400VAC 50Hz; 440-460VAC 60Hz



## Options

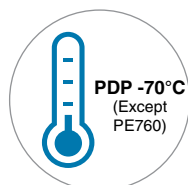

**PDP -70°C**  
(Except PE760)

**PDP -70°C**  
(Except PE760)



**In and outlet filters**



**Wooden packaging**  
(Std on PE760)



**PDP control**



**Vessel insulation**  
(required for  
PDP-70°C option)



**Vessel safety valves**  
(Std on PE760)

<sup>1</sup>For PE760S (-40°C PDP) Desiccant used is silica gel WR & NWR.





With distinctive, patented technology, PE adsorption dryers provide you with a dry air solution; at a lower initial investment cost than PB blower purge dryers and a lower lifecycle cost than PH heatless dryers. PE dryers use heated purge air to remove moisture from the desiccant material.

PE 760S-3390S adsorption dryers are capable of drying air to a PDP of -40°C/-40°F as standard and -70°C/-94°F as option. The desiccant is housed in welded vessels, which are coated and can

operate up to 10 barg/145 psig (fatigue load). Mounted pre- and after- filters can be ordered as an option.

The Purelogic™ is the central brain of the adsorption dryer. It optimizes operating costs thanks to the availability of regeneration temperature control, PDP control (optional) and compressor synchronization; ensures maximum reliability by monitoring the most important parameters of the dryer; and offers impressive control and monitoring capabilities.

#### Technical specifications for PE 760S up to PE 3390S (standard version, PDP -40 °C)

Specification	Unit	PE 760 S	PE 1020 S	PE 1330 S	PE 2060 S	PE 2670 S	PE 3390 S
Nominal volume flow at dryer inlet <sup>(1) (2)</sup>	l/s	360	480	630	970	1260	1600
	m <sup>3</sup> /hr	1296	1728	2268	3492	4536	5760
Average purge air consumption	%	10	10	10	10	10	10
Pressure drop at max. flow	barg	0.27	0.17	0.17	0.17	0.17	0.11
	psig	3.92	2.47	2.47	2.47	2.47	1.60
Inlet and outlet connections	PN16	DN 50	DN 80	DN 80	DN 100	DN 100	DN 150
Optional pre & after filter sizes <sup>(3)</sup>	Fine filter	PMH G 1189	PMH G 1529	PMH G 2125	FF 2 G HE	FF 3 G HE	FF 4 G HE
	Super fine filter	PMH C 1189	PMH C 1529	PMH C 2125	FF 2 C HE	FF 3 C HE	FF 4 C HE
	Dust filter	PMH S 1189	PMH S 1529	PMH S 2125	FF 2 S HE	FF 3 S HE	FF 4 S HE
Mass	Kg	820	1130	1410	2280	2750	3560
	Lb	1808	2491	3109	5027	6063	7848
Height	mm	1829	2558	2612	2702	2684	2603
	inch	72	101	103	106	106	102
Width	mm	1075	930	930	1085	1085	1342
	inch	42	37	37	43	43	53
Length	mm	1100	1764	1884	2359	2472	2708
	inch	43	69	74	93	97	107

1. Flow is measured at reference conditions: 1 bara and 20°C at operating pressure of 7 barg, inlet temperature 35°C & std PDP of -40°C at the outlet.

2. Dryer designed for mentioned volume flow, based on average duty of 80%.

3. Filters are sized at reference conditions. Consult the AML of the filters for sizing outside the reference conditions.

#### Correction factor Kp x Kt for -40°C PDP

T inlet	Working pressure barg (psig)													
°C (°F)	4.5 (65)	5 (73)	6 (87)	7 (102)	8 (116)	9 (131)	10 (145)							
<=20 (68)	"1,00"													
25 (77)								0.89						
30 (86)								0.74	0.87					
35 (95)								0.59	0.7	0.88				
40 (104)								0.42	0.5	0.62	0.71	0.8	0.89	0.98
45 (113)								0.29	0.34	0.43	0.49	0.55	0.61	0.67

Notes for PDP-40 variants

1) Correction factors are for 100% saturated compressed air

#### Correction factor Kp x Kt for -70°C PDP

T inlet	Working pressure barg (psig)													
°C (°F)	4.5 (65)	5 (73)	6 (87)	7 (102)	8 (116)	9 (113)	10 (145)							
<=20 (68)	"1,00"													
25 (77)								0.89						
30 (86)								0.74	0.87					
35 (95)								0.59	0.70	0.88				
40 (104)								0.45	0.53	0.67	0.76	0.86	0.95	
45 (113)								0.34	0.40	0.51	0.58	0.65	0.73	0.80

Notes for PDP-70 variants

1) Correction factors are for 80% saturated compressed air

# PB 210 - 635 HE (P/ZP) - Blower purge/zero purge adsorption dryers

## Features & Benefits

- ▶ Advanced energy management for lowest operating costs
  - Compressor synchronization
  - PDP control
  - Regeneration & cooling temperature control
  - Purge nozzle optimization (optional)
- ▶ Zero-purge variants for lowest life-cycle costs
  - Purge back-up mode for ambient conditions outside of limitations
- ▶ High-quality, high-efficient desiccant, selected for the right application
  - PDP -40°C/-40°F (std): silica gel WR & NWR
  - PDP -70°C/-94°F (optional): molecular sieves
- ▶ Minimal risk of crushed desiccant thanks to the sonic nozzle and the large vessel diameter
- ▶ Counter-current regeneration for optimal energy efficiency and guaranteed dry air
- ▶ High reliability and robust design
- ▶ Low noise levels while purging
- ▶ Designed for transportability
- ▶ High efficient heaters, designed for maximum lifetime and minimal risk
- ▶ Compact, efficient and reliable side-channel centrifugal blower
- ▶ Optimal control and monitoring thanks to the Purelogic™ controller

## General Specifications

- ▶ Blower purge & zero purge adsorption dryers: welded vessel design
- ▶ Dew points achievable: -40°C/-40°F & -70°C/-94°F (-70°C/-94°F only with Purge Cooled option)
- ▶ Pressure range: 4-14 barg/58-203 psig
- ▶ Ambient temperature range: 1-45°C/34-113°F
- ▶ Inlet temperature range: 1-50°C/34-122°F
- ▶ Power supply: 400VAC 50Hz; 440-460VAC 60Hz



## Options

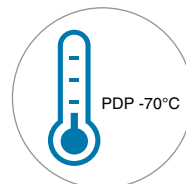

**-70°C PDP variant available**  
(only available on blower purge variants)



**Reverse in and outlet pipe**



**NEMA 4 electrical enclosure**



**Insulated vessels**



**Inlet blower filters**



**Purge nozzle optimization**



PB dryers are for customers who focus on energy efficiency and low lifecycle costs, while maintaining the highest standards in air purity. PB dryers use heated blower purge air to remove moisture from the desiccant material and have therefore no purge loss during regeneration. The Zero Purge variants reduce life cycle cost even further by also eliminating purge loss during cooling.

PB 210-635 HE adsorption dryers are capable of drying air to a PDP of -40°C/-40°F as standard and -70°C/-94°F as option for purge units. The desiccant is housed in welded vessels, which are coated and can operate up to 14.5 barg/210 psig (fatigue load). All dryers are standard equipped with 2 coalescing pre-filters before and 1 particulate filter after the dryer.

Operating costs are reduced to the absolute minimum thanks to PDP control, regeneration & cooling temperature control and compressor synchronization; which are all integrated in the Purelogic™ controller. Zero Purge variants are equipped with a purge back-up mode which switches the dryer to purge cooling mode in case PDP could not be met at ambient conditions outside of limitations. The Purelogic™ also ensures maximum reliability by monitoring the most important parameters of the dryer and offers impressive control and monitoring capabilities.

### Technical specifications for PB 210 HE up to PB 635 HE (ZP) (standard version, PDP -40°C)

Specification	Unit	PB 210HE	PB 320 HE	PB 390 HE	PB 530 HE	PB 635 HE	PB210HEZP	PB320HEZP	PB390HEZP	PB530HEZP	PB 635 HE ZP
Cooling Mode	-	Purge	Purge	Purge	Purge	Purge	Zero Purge	Zero Purge	Zero Purge	Zero Purge	Zero Purge
Nominal volume flow at dryer inlet <sup>(1)</sup>	l/s	100	150	185	250	300	100	150	185	250	300
	m <sup>3</sup> /hr	360	540	666	900	1080	360	540	666	900	1080
Purge air consumption average	%	2	2	2	2	2	0	0	0	0	0
Pressure Drop Over Dryer	barg	0.2	0.2	0.2	0.2	0.2	0.2	0.2	0.2	0.2	0.2
	psig	2.90	2.90	2.90	2.90	2.90	2.90	2.90	2.90	2.90	2.90
Inlet and outlet connections	G	1 ½"	1 ½"	1 ½"	2"	2"	1 ½"	1 ½"	1 ½"	2"	2"
	NPT	1 ½"	1 ½"	1 ½"	2"	2"	1 ½"	1 ½"	1 ½"	2"	2"
Included pre and after filters	Fine filter	TF 6 G HE	TF 7 G HE	TF 8 G HE	TF 9 G HE	TF 9 G HE	TF 6 G HE	TF 7 G HE	TF 8 G HE	TF 9 G HE	TF 9 G HE
	Super fine filter	TF 6 C HE	TF 7 C HE	TF 8 C HE	TF 9 C HE	TF 9 C HE	TF 6 C HE	TF 7 C HE	TF 8 C HE	TF 9 C HE	TF 9 C HE
	Dust filter	TF 6 S HE	TF 7 S HE	TF 8 S HE	TF 9 S HE	TF 9 S HE	TF 6 S HE	TF 7 S HE	TF 8 S HE	TF 9 S HE	TF 9 S HE
Height	mm	1720	1770	1770	1816	1853	1855	1891	1891	1969	2006
	inch	67.7	69.7	69.7	71.5	73.0	73.0	74.4	74.4	77.5	79.0
Width	mm	770	870	870	955	1010	840	966	966	1098	1123
	inch	30.3	34.3	34.3	37.6	39.8	33.1	38.0	38.0	43.2	44.2
Length	mm	1250	1300	1300	1345	1425	1174	1360	1360	1580	1507
	inch	49.2	51.2	51.2	53.0	56.1	46.2	53.5	53.5	62.2	59.3
Mass	Kg	640	680	710	775	820	400	498	537	663	765
	Lb	1411	1499	1565	1709	1808	882	1098	1184	1462	1687

1. Flow is measured at reference conditions: 1 bara and 20°C at operating pressure of 7 barg, inlet temperature 35°C & std PDP of -40°C at the outlet. (For ZP versions inlet temperature is 33°C)

#### Flow correction factors due to air inlet pressure

Operating pressure	barg	4.5	5	6	7	8	9	10	11	12	13	14
	psig	65	72	87	100	116	130	145	160	174	189	203
Pressure correction factor	Kp	0.687	0.75	0.88	1	1.13	1.25	1.38	1.5	1.62	1.74	1.86

#### Flow correction factors due to air inlet temperature (For -40°C PDP Units with Silica Gel)

Temperature	°C	20	25	30	35	40	45
	°F	68	77	86	95	104	113
Temperature correction factor	Kt	1	1	1	1	0.75	0.55

#### Flow correction factors due to air inlet temperature (For -70°C PDP Units with Molecular Sieves)

Temperature	°C	20	25	30	35	40	45	50	55
	°F	68	77	86	95	104	113	122	131
Temperature Correction Factor	Kt	1	1	1	1	1	0.78	0.61	0.49

#### Flow correction factors due to Pressure Dew Point (For 11 barg Units)

Dew point	°C	0	-40	-70
	°F	32	-40	-94
Dew point correction factor	Kdp	1	1	0.8

# PB 700 - 6350 HE (P/ZP) - Blower purge/zero purge adsorption dryers

## Features & Benefits

- ▶ Advanced energy management for lowest operating costs
  - Compressor synchronization
  - PDP control
  - Regeneration & cooling temperature control
  - Purge nozzle optimization (optional)
- ▶ Zero-purge variants with cooling in closed loop
  - Lowest life-cycle costs
  - Excellent performance at high ambient temperatures
  - Frequency controlled blower to guarantee optimal cooler performance
- ▶ High-quality, high-efficient desiccant, selected for the right application
  - PDP -40°C/-40°F (std): silica gel + activated alumina
  - PDP -70°C/-94°F and HIT (optional): activated alumina & molecular sieves
- ▶ Minimal risk of crushed desiccant thanks to the sonic nozzle and the large vessel diameter
- ▶ Counter-current regeneration for optimal energy efficiency and guaranteed dry air
- ▶ High reliability and robust design
- ▶ Low noise levels while purging
- ▶ Designed for transportability
- ▶ Optimal control and monitoring thanks to the Purelogic™ controller

## General Specifications

- ▶ Blower purge & zero purge adsorption dryers: welded vessel design
- ▶ Dew points achievable:
  - 40°C/-40°F & -70°C/-94°F
  - (-70°C/-94°F only with Zero Purge variants)
- ▶ Pressure range: 4-10 barg/58-145 psig  
(14 barg/ 203 psig available on request)
- ▶ Ambient temperature range:
  - 1-45°C/34-113°F (For temperatures above 40°C and up to 55°C see High Ambient Temp. option)
- ▶ Inlet temperature range: 1-45°C/34-113°F  
(For temperatures above 45°C see HIT option)
- ▶ Power supply: 400VAC 50Hz;  
440-460VAC 60Hz



## Options

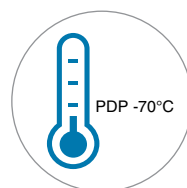

**-70°C PDP variant available**  
(only for ZP variants)



**Insulated vessels**  
(std on -70°C PDP Variant)



**Inlet blower filters**



**2nd PDP read out**



**Purge nozzle optimization**



**External pilot air connection for low pressure inlet**

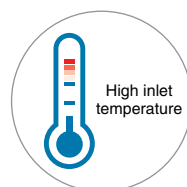

**High inlet temperature variant**  
(not applicable on -70°C PDP)

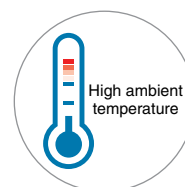

**High ambient temperature variant**



**In and outlet filters**



**Vessel safety valves**



**Wooden packaging**



PB dryers are for customers who focus on energy efficiency and low lifecycle costs, while maintaining the highest standards in air purity. Pneumatech extends its PB dryer range to flows up to 10800 m<sup>3</sup>/hr with both blower purge and Zero Purge variants.

PB dryers use heated blower purge air to remove moisture from the desiccant material and have therefore no purge loss during regeneration. The Zero Purge variants reduce life cycle costs even further by also eliminating purge loss during cooling. The cooling phase happens in a closed loop, hereby minimizing the performance impact at high ambient temperature and relative humidity.

PB 700-6350 HE ZP dryers are capable of drying air to a PDP of -40°C/-40°F as standard and -70°C/-94°F as option. The desiccant is housed in welded vessels, which are coated and can operate up to 10 barg/145 psig (fatigue load). All dryers can be equipped with 2 coalescing pre-filters before and 1 particulate filter after the dryer.

Operating costs are reduced to the absolute minimum thanks to PDP control, regeneration & cooling temperature control and compressor synchronization; which are all integrated in the Purelogic™ controller. The Purelogic™ also ensures maximum reliability by monitoring the most important parameters of the dryer and offers impressive control and monitoring capabilities.

**Technical specifications for PB 700 HE up to PB 6350 HE (standard version, PDP -40 °C)**

Specification	Unit	PB700 HE	PB850 HE	PB1150 HE	PB1800 HE	PB2350 HE	PB2950 HE	PB3800 HE	PB4650 HE	PB6350 HE	PB700 HE ZP	PB850 HE ZP	PB1150 HE ZP	PB1800 HE ZP	PB2350 HE ZP	PB2950 HE ZP	PB3800 HE ZP	PB4650 HE ZP	PB6350 HE ZP
Cooling Mode	-	Purge	Purge	Purge	Purge	Purge	Purge	Purge	Purge	Purge	Zero Purge Air Cooled	Zero Purge Air Cooled	Zero Purge Air Cooled	Zero Purge Air Cooled	Zero Purge Air Cooled	Zero Purge Water Cooled	Zero Purge Water Cooled	Zero Purge Water Cooled	Zero Purge Water Cooled
Nominal volume flow at dryer inlet <sup>(1)</sup>	l/s	330	400	550	850	1100	1400	1800	2200	3000	330	400	550	850	1100	1400	1800	2200	3000
	m <sup>3</sup> /hr	1188	1440	1980	3060	3960	5040	6480	7920	10800	1188	1440	1980	3060	3960	5040	6480	7920	10800
Avg. purge air consumption	%	2%	2%	2%	2%	2%	2%	2%	2%	2%	0	0	0	0	0	0	0	0	0
Pressure drop over dryer	barg	0.12	0.12	0.12	0.12	0.12	0.1	0.16	0.22	0.18	0.12	0.12	0.12	0.12	0.12	0.1	0.16	0.22	0.18
	psig	1.74	1.74	1.74	1.74	1.74	1.45	2.32	3.19	2.61	1.74	1.74	1.74	1.74	1.74	1.45	2.32	3.19	2.61
Inlet and outlet connections	DN, acc to DIN2633 PN16	80	80	80	100	100	150	150	150	200	80	80	80	100	100	150	150	150	200
Optional pre & after filter sizes <sup>(2)</sup>	Fine filter	PMH G 1529	PMH G 1529	FF 1 G HE	FF 2 G HE	FF 3 G HE	FF 4 G HE	FF 5 G HE	FF 6 G HE	FF 7 G HE	TF 10 G HE	TF 10 G HE	FF 1 G HE	FF 2 G HE	FF 3 G HE	FF 4 G HE	FF 5 G HE	FF 6 G HE	FF 7 G HE
	Super fine filter	PMH C 1529	PMH C 1529	FF 1 C HE	FF 2 C HE	FF 3 C HE	FF 4 C HE	FF 5 C HE	FF 6 C HE	FF 7 C HE	TF 10 C HE	TF 10 C HE	FF 1 C HE	FF 2 C HE	FF 3 C HE	FF 4 C HE	FF 5 C HE	FF 6 C HE	FF 7 C HE
	Dust filter	PMH S 1529	PMH S 1529	FF 1 S HE	FF 2 S HE	FF 3 S HE	FF 4 S HE	FF 5 S HE	FF 6 S HE	FF 7 S HE	TF 10 S HE	TF 10 S HE	FF 1 S HE	FF 2 S HE	FF 3 S HE	FF 4 S HE	FF 5 S HE	FF 6 S HE	FF 7 S HE
Mass	Kg	1190	1300	1620	2600	3040	4200	4800	5750	7800	1370	1490	1830	2840	3340	4550	5150	6100	8150
	Lb	2624	2866	3571	5732	6702	9259	10582	12677	17196	3020	3285	4034	6261	7363	10031	11354	13448	17968
Height	mm	2558	2558	2612	2702	2681	2488	2548	2548	2793	2558	2558	2612	2702	2681	2548	2548	2548	2893
	inch	100.7	100.7	102.8	106.4	105.6	98.0	100.3	100.3	110.0	100.7	100.7	102.8	106.4	105.6	100.3	100.3	100.3	113.9
Width	mm	1024	1024	1024	1175	1175	2373	2400	2792	2834	1351	1351	1428	1530	1530	2779	2825	3009	3053
	inch	40.3	40.3	40.3	46.3	46.3	93.4	94.5	109.9	111.6	53.2	53.2	56.2	60.2	60.2	109.4	111.2	118.5	120.2
Length	mm	1764	1764	1884	2359	2472	2809	2830	2993	3385	1764	1764	1884	2359	2472	3122	3197	3197	3792
	inch	69.4	69.4	74.2	92.9	97.3	110.6	111.4	117.8	133.3	69.4	69.4	74.2	92.9	97.3	122.9	125.9	125.9	149.3

1. Flow is measured at reference conditions: 1 bara and 20°C at operating pressure of 7 barg, inlet temperature 35°C & std PDP of -40°C at the outlet.  
 2. Filters are sized at reference conditions. Consult the AML of the filters for sizing outside the reference conditions.

**Correction factor Kp x Kt for PDP-40**

T inlet °C (°F)	Working pressure barg (psig)						
	4.5 (65)	5 (73)	6 (87)	7 (102)	8 (116)	9 (131)	10 (145)
<=20 (68)	"1.00"						
25 (77)	0.89	"1.00"					
30 (86)	0.74	0.87	"1.00"				
35 (95)	0.59	0.7	0.88	"1.00"			
40 (104)	0.42	0.5	0.62	0.71	0.8	0.89	0.98
45 (113)	0.29	0.34	0.43	0.49	0.55	0.61	0.67

Notes for PDP-40 variants

- 1) Correction factor are for 100% saturated compressed air
- 2) For temperatures above 45 deg C see HIT-variant



# PB 760 - 3390 S - The cost efficient alternative to PB 700-2950 HE

## Features & Benefits

- ▶ Advanced energy management for lowest operating costs
  - Compressor synchronization
  - PDP control (optional)
  - Regeneration & cooling temperature control
- ▶ High-quality, high-efficient desiccant, selected for the right application activated alumina
- ▶ Minimal risk of crushed desiccant thanks to the sonic nozzle and the large vessel diameter
- ▶ Counter-current regeneration for optimal energy efficiency and guaranteed dry air
- ▶ High reliability and robust design
- ▶ Low noise levels while purging
- ▶ Designed for transportability
- ▶ High efficient heaters, designed for maximum lifetime and minimal risk
- ▶ Compact, efficient and reliable side-channel centrifugal blower
- ▶ Optimal control and monitoring thanks to the Purelogic™ controller

## General Specifications

- ▶ Blower purge adsorption dryers: welded vessel design
- ▶ Dew points achievable: -40°C/-40°F
- ▶ Pressure range: 4-10 barg/58-145 psig
- ▶ Ambient temperature range: 1-40°C/34-104°F  
For ambient temperatures above 40 deg C see High Ambient Temperature variant
- ▶ Inlet temperature range: 1-45°C/34-113°F  
For temperatures above 45 deg C see HIT-variant
- ▶ Power supply: 400VAC 50Hz;  
440-460VAC 60Hz



## Options



**Blower inlet filter**



**In and outlet filters**



**Vessel safety valves**



**External pilot air connection**



**PDP control**



**Wooden packaging**



**Vessel insulation**

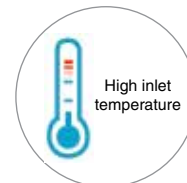

**High inlet temperature**

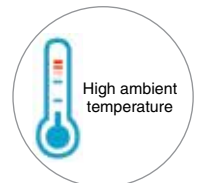

**High ambient temperature**  
(not on PB760S)



PB dryers are for customers who focus on energy efficiency and low lifecycle costs, while maintaining the highest standards in air purity. PB dryers use heated blower purge air to remove moisture from the desiccant material and have therefore no purge loss during regeneration.

PB 760-3390 S adsorption dryers are capable of drying air to a PDP of -40°C/-40°F. The desiccant is housed in welded vessels, which are coated and can operate up to

10 barg/145 psig (fatigue load). Mounted pre- and after-filters can be ordered as an option.

The Purelogic™ is the central brain of the adsorption dryer. It optimizes operating costs thanks to the availability of regeneration & cooling temperature control, PDP control (optional) and compressor synchronization; ensures maximum reliability by monitoring the most important parameters of the dryer; and offers impressive control and monitoring capabilities.

#### Technical specifications for PB 760S up to PB 3390S (standard version, PDP -40 °C)

Specification	Unit	PB 760 S	PB 1020 S	PB 1330 S	PB 2060 S	PB 2670 S	PB 3390 S
Maximum volume flow at dryer inlet <sup>(1) (2)</sup>	l/s	360	480	630	970	1260	1600
	m <sup>3</sup> /hr	1296	1728	2268	3492	4536	5760
Average purge air consumption <sup>(3)</sup>	%	2%	2%	2%	2%	2%	2%
Pressure drop over dryer	barg	0.2	0.16	0.16	0.16	0.16	0.11
	psig	2.9	2.32	2.32	2.32	2.32	1.60
Inlet and outlet connections	G Thread/DN, acc to DIN2633 PN16	ISO 7-R2" <sup>(2)</sup>	DN80	DN80	DN100	DN100	DN150
Optional pre & after filter sizes <sup>(4)</sup>	Fine filter	TF 9 G S	TF 10 G S	TF 11 G S	FF 2 G HE	FF 3 G HE	FF 4 G HE
	Super fine filter	TF 9 C S	TF 10 C S	TF 11 C S	FF 2 C HE	FF 3 C HE	FF 4 C HE
	Dust filter	TF 9 S S	TF 10 S S	TF 11 S S	FF 2 S HE	FF 3 S HE	FF 4 S HE
Mass	Kg	1160	1355	1700	2720	3185	4470
	Lb	2557	2987	3748	5997	7022	9855
Height	mm	1829	2558	2612	2702	2681	2488
	inch	72.0	100.7	102.8	106.4	105.6	98.0
Width	mm	1028	1024	1024	1175	1175	2373
	inch	40.5	40.3	40.3	46.3	46.3	93.4
Length	mm	1100	1764	1884	2359	2472	2809
	inch	43.3	69.4	74.2	92.9	97.3	110.6

1. Flow is measured at reference conditions: 1 bara and 20°C at operating pressure of 7 barg, inlet temperature 35°C & std PDP of -40°C at the outlet.

2. Dryer designed for mentioned volume flow, based on average duty of 80%.

2. Specially designed adapters are to be used when no filter is ordered.

4. Filters are sized at reference conditions. Consult the AML of the filters for sizing outside the reference conditions.

#### Correction factor K<sub>p</sub> x K<sub>t</sub> for PDP-40

T inlet	Working pressure barg (psig)												
°C (°F)	4.5 (65)	5 (73)	6 (87)	7 (102)	8 (116)	9 (131)	10 (145)						
<=20 (68)	"1,00"												
25 (77)								0.89					
30 (86)								0.74	0.87				
35(95)								0.59	0.7	0.88			
40(104)								0.42	0.5	0.62	0.71	0.8	0.89
45(113)	0.29	0.34	0.43	0.49	0.55	0.61	0.67						

Notes for PDP-40°C variants

1) Correction factor are for 100% saturated compressed air.

## In-house design & manufacturing

Within Pneumatech we design and produce all our core drying, filtration and gas generator products in-house. We invest 3% of our total revenues in R&D. This results in an expert know-how of drying & filtration mechanisms, state-of-the-art test facilities and breakthrough innovations. From operations side, we distinct ourselves with our high level of automation and quality control in triple certified manufacturing production plants.







# Refrigeration dryers

With our refrigeration dryers too, we let you choose between investment cost and lifecycle cost.

Pneumatech's COOL range is our robust, no-frills drying solution, meant for basic condensate removal in your compressed air system. With the AD dryers we guarantee dry air through real-time PDP monitoring, while also reducing power consumption and compressed air losses. Our premium AC dryers optimize the energy consumption based on the actual compressed air demand, through energy saving algorithms or variable speed technology.

# Cool 12 - 272 - Non-cycling refrigeration dryers

## Features & Benefits

- ▶ Solid performance & strong reliability
  - Stable pressure dew point as low as 5°C/41°F ensuring ISO 8573-1 class 5 quality
- ▶ Compact & easy to install
  - Simple vertical design
  - Plug- and play mechanical & electrical connections
- ▶ Super cost saver
  - Low initial investment
  - Efficient cooling system ensures low energy costs
  - Increased lifetime of tools and equipment
- ▶ Easy maintenance at low cost
  - Long service intervals
  - Easy access to key components

## General Specifications

- ▶ Non-cycling refrigeration dryers
- ▶ Operating pressure: 4-16 barg/58-232 psig (4-13 barg/58-189 psig from COOL 145 onwards)
- ▶ Max. ambient temperature: 50°C/122°F
- ▶ Flow rate: 21 to 462 m³/hr (12-272 cfm)<sup>(1)</sup>
- ▶ Pressure dew point: 5°C/41°F (ISO 8573-1:2010 class 5)
- ▶ Power supply: 230VAC 50 Hz (60Hz version on request)
- ▶ Refrigerant: R134a (COOL 12-145) or R410A (COOL 184-272)



## Applications



**Pneumatic tools and equipment**



**Pneumatic control systems**



**Painting**



**Injection moulding**



**Car shops**



**Tire inflations**

<sup>1</sup> Flow is measured at reference conditions: ambient pressure of 1 bara and 25°C at operating pressure of 7 barg, inlet temperature 35°C .



The compressed air coming out of the compressor is always saturated. Pneumatech's reliable and robust COOL refrigeration dryers are an efficient solution to lower the presence of moisture and the resultant corrosion in your compressed air system. COOL dryers can act as a second line of defence after water separators and aftercoolers giving you a stable dew point as low as 5°C/41°F, maintaining the ISO 8573-1 class 5 air quality.

Designed to work up to 16 barg/232 psig, COOL dryers deliver stable performance thanks to the efficient refrigerant gas and carefully selected components. The simple vertical design and small foot print make COOL dryers the easy-to-use drying solution in various industrial applications such as car shops, spray painting, injection moulding, tire inflation and many more.

Technical specifications for COOL 12-272 50 Hz													
Pneumatech Variants →	Units	COOL 12	COOL 21	COOL 30	COOL 42	COOL 64	COOL 76	COOL 106	COOL 127	COOL 145	COOL 184	COOL 230	COOL 272
Specifications ↓													
Flow <sup>(1)</sup>	l/s	5.8	10.0	14.2	20.0	30.4	35.8	50.0	60.0	68.3	86.7	108.3	128.3
	m <sup>3</sup> /hr	21	36	51	72	110	129	180	216	246	312	390	462
Nominal electric power	kW	0.13	0.13	0.16	0.28	0.32	0.30	0.42	0.68	0.74	0.70	0.75	0.95
Power Supply Voltage/Phase		230/50/1	230/50/1	230/50/1	230/50/1	230/50/1	230/50/1	230/50/1	230/50/1	230/50/1	230/50/1	230/50/1	230/50/1
Max Operating Pressure	barg	16	16	16	16	16	16	16	16	13	13	13	13
	psig	232	232	232	232	232	232	232	232	188	188	188	188
Refrigerant Gas		R134a	R134a	R134a	R134a	R134a	R134a	R134a	R134a	R134a	R410A	R410A	R410A
Inlet and Outlet Connections	G Threads	1/2" F	1/2" F	1/2" F	1/2" F	1/2" F	3/4" F	1" F	1" F	1 1/2" F	1 1/2" F	1 1/2" F	1 1/2" F
Dimensions	L (mm)	233	233	233	233	233	233	233	310	310	310	310	310
	L (inch)	8.8	8.8	8.8	8.8	8.8	8.8	8.8	12.2	12.2	12.2	12.2	12.2
	W (mm)	550	550	550	550	550	550	559	706	706	706	706	706
	W (inch)	22	22	22	22	22	22	22	27.8	27.8	27.8	27.8	27.8
	H (mm)	561	561	561	561	561	561	561	994	994	994	994	994
	H (inch)	22.1	22.1	22.1	22.1	22.1	22.1	22.1	39.1	39.1	39.1	39.1	39.1
Weight	kg	19	19	19	20	25	27	30	52	57	59	80	80
	lb	42	42	42	44	55	59	66	114	125	130	176	176

1.Flow is measured at reference conditions: ambient pressure of 1 bara and 25°C at operating pressure of 7 barg, inlet temperature 35°C.

Correction factors for ambient temperature					
Ambient temperature	°C	25	30	35	40
	°F	77	86	95	104
Temperature correction factor	Kt (amb)	1	0.92	0.84	0.8

Correction factors for compressed air inlet temperature						
Inlet temperature	°C	30	35	40	45	50
	°F	86	95	104	113	122
Temperature correction factor	Kt	1.24	1	0.8	0.69	0.54

Correction factors for compressed air inlet pressure													
Operating pressure	barg	5	6	7	8	9	10	11	12	13	14	15	16
	psig	73	87	101	116	131	145	159	174	188	203	218	232
Pressure correction factor	Kp	0.9	0.96	1	1.03	1.06	1.08	1.1	1.12	1.13	1.15	1.16	1.17

# AD 10 - 3000 - Non-cycling refrigeration dryers

## General specifications

- ▶ Non-cycling refrigeration dryers
- ▶ Operating Pressure:
  - AD10 - 50: 4-16 barg/60-232 psig
  - AD75 - 3000: 4-13 barg/60-188 psig
- ▶ Max. inlet temperature: 55°C/113°F
- ▶ Flow rate: 21 - 5040 m<sup>3</sup>/hr/  
12-2966 cfm<sup>(1)</sup>
- ▶ Pressure dew point: 3°C/37°F  
(ISO 8573 - 1:2010 class 4)
- ▶ Power supply:
  - AD10 - 250: 230VAC 50/60 Hz
  - AD300 - 3000: 400V/50Hz; 380V/60Hz;  
460V/60Hz
- ▶ Refrigerant: R134a (AD10 - 50);  
R410A (AD125 - 1250) & R452A  
(AD75 - 100 & AD1600 - 3000)

## Refrigeration Dryers: AD Series (10-3000) Non cycling

AD 10-50	AD 75-100
	
Features & Benefits	Features & Benefits
<ul style="list-style-type: none"> <li>• Stable performance and guaranteed dew point of 3°C/37°F</li> <li>• Ingeniously designed components to ensure maximum performance                             <ul style="list-style-type: none"> <li>• Hot gas bypass valve to prevent freezing at lower loads</li> <li>• Zero-loss electronic drain to prevent loss of valuable compressed air</li> <li>• Brazed plate heat exchanger with integrated water separator and air-to-air heat exchange</li> </ul> </li> <li>• R134a refrigerant gas: low global warming impact, zero ozone depletion</li> <li>• Digital display with real-time PDP monitoring</li> <li>• Easy plug-and-play installation</li> </ul>	<ul style="list-style-type: none"> <li>• Stable performance and guaranteed dew point of 3°C/37°F</li> <li>• Ingeniously designed components to ensure maximum performance                             <ul style="list-style-type: none"> <li>• Hot gas bypass valve to prevent freezing at lower loads</li> <li>• Zero-loss electronic drain to prevent loss of valuable compressed air</li> <li>• Aluminium block heat exchanger with integrated water separator and air-to-air heat exchange</li> </ul> </li> <li>• Environmental safe refrigerant gases R452A</li> <li>• Digital display with real-time PDP monitoring</li> <li>• Easy plug-and-play installation</li> </ul>

## Options



**Filter support**



**Bypass valve**

Pneumatech's AD 10-3000 non-cycling refrigeration dryers are designed to protect your compressed air system by lowering the presence of moisture in the compressed air. With a stable dew point as low as 3°C/37°F these dryers provide a highly efficient and reliable solution for your drying needs. Thanks to the new controller with digital display, real time PDP monitoring is possible. The zero-loss electronic drains avoid compressed air losses. The well-designed heat exchangers ensure maximum cooling efficiency, making the AD dryers a genuine air drying solution in industrial applications.

The AD125-1250 range is equipped with the winning combination: rotary compressors and R410A refrigerant. This combination is up to 30% more energy efficient, requires 19% less refrigerant gas and is 100% compliant with European regulation EU No 517/2014, hereby significantly reducing the ecological footprint of these dryers. Rotary compressors are moreover very reliable thanks to the low vibration levels and limited mechanical load. R410A guarantees stable evaporation, which makes the pressure dew point of 3°C/37°F possible.

AD 125-250	AD 300-1250	AD1600 - 3000
		
<p align="center"><b>Features &amp; Benefits</b></p>	<p align="center"><b>Features &amp; Benefits</b></p>	<p align="center"><b>Features &amp; Benefits</b></p>
<ul style="list-style-type: none"> <li>• Stable performance and guaranteed dew point of 3°C/37°F</li> <li>• Rotary compressors and R410A refrigerant: the winning combination               <ul style="list-style-type: none"> <li>• 30% more energy efficient</li> <li>• Requires 19% less refrigerant gas</li> </ul> </li> <li>• Extremely reliable: low vibration levels and limited mechanical load</li> <li>• Ingeniously designed components to ensure maximum performance               <ul style="list-style-type: none"> <li>• Hot gas bypass valve to prevent freezing at lower loads</li> <li>• Zero-loss electronic drain to prevent loss of valuable compressed air</li> <li>• Aluminium block heat exchanger with integrated water separator and air-to-air heat exchange</li> </ul> </li> <li>• Digital display with real-time PDP monitoring and voltage-free contact for remote alarm</li> <li>• Easy plug-and-play installation</li> </ul>	<ul style="list-style-type: none"> <li>• Stable performance and guaranteed dew point of 3°C/37°F</li> <li>• Rotary compressors and R410A refrigerant: the winning combination               <ul style="list-style-type: none"> <li>• 30% more energy efficient</li> <li>• Requires 19% less refrigerant gas</li> </ul> </li> <li>• Extremely reliable: low vibration levels and limited mechanical load</li> <li>• Ingeniously designed components to ensure maximum performance               <ul style="list-style-type: none"> <li>• Hot gas bypass valve to prevent freezing at lower loads</li> <li>• Zero-loss electronic drain to prevent loss of valuable compressed air</li> <li>• Aluminium block heat exchanger with integrated water separator and air-to-air heat exchange</li> </ul> </li> <li>• Advanced controlling and monitoring thanks to the controller installed               <ul style="list-style-type: none"> <li>• Digital PDP display</li> <li>• Remote start/stop</li> <li>• Voltage-free contact for general alarm</li> </ul> </li> <li>• Easy plug-and-play installation</li> </ul>	<ul style="list-style-type: none"> <li>• Stable performance and guaranteed dew point of 3°C/37°F.</li> <li>• Ingeniously designed components to ensure maximum performance               <ul style="list-style-type: none"> <li>• Hot gas bypass valve to prevent freezing at lower loads</li> <li>• Zero-loss electronic drain to prevent loss of valuable compressed air</li> <li>• Aluminium block heat exchanger with integrated water separator and air-to-air heat exchange</li> </ul> </li> <li>• Environmental safe refrigerant gases R452A</li> <li>• Advanced controlling and monitoring               <ul style="list-style-type: none"> <li>• Digital PDP display</li> <li>• Remote start/stop</li> <li>• Voltage-free contact for general alarm</li> </ul> </li> <li>• Easy plug-and-play installation</li> </ul>

<sup>1</sup> Flow is measured at reference conditions: ambient pressure of 1 bara and 25°C at operating pressure of 7 barg, inlet temperature 35°C .

# AD 10 - 3000 - Non-cycling refrigeration dryers

## Technical specifications for AD 10-3000 50Hz

Pneumatech Variants → Specifications ↓		AD 10	AD 15	AD 25	AD 35	AD 50	AD 75	AD 100	AD 125	AD 150	AD 175	AD 200	AD 250	AD 300	AD 360	AD 500	AD 600	AD 750	AD 1000	AD 1250	AD 1600	AD 1800	AD 2500	AD 3000
Flow <sup>(1)</sup>	l/s	5.8	10.0	14.2	20.0	30.6	39.2	50.0	60.0	68.3	86.7	108.3	128.3	166.7	200.0	250.0	300.0	400.0	500.0	583.3	750.0	833.3	1166.7	1400.0
	m <sup>3</sup> /hr	21	36	51	72	110	141	180	216	246	312	390	462	600	720	900	1080	1440	1800	2100	2700	3000	4200	5040
Nominal electric power	kW	0.13	0.164	0.19	0.266	0.284	0.674	0.716	0.66	0.663	0.835	1.016	1.136	1.319	1.631	1.889	2.11	3.26	3.89	4.75	6.715	6.8	10.2	12.3
Power Supply/ Voltage/Phase	V/Hz/Ph	230 50 1	230 50 1	230 50 1	230 50 1	230 50 1	230 50 1	230 50 1	230 50 1	230 50 1	230 50 1	230 50 1	230 50 1	400 50 3	400 50 3	400 50 3	400 50 3	400 50 3	400 50 3	400 50 3	400 50 3	400 50 3	400 50 3	400 50 3
Max Operating Pressure	bar	16	16	16	16	16	14	14	14	14	14	14	14	14	14	14	14	14	14	14	14	14	14	14
	psi	232	232	232	232	232	203	203	203	203	203	203	203	203	203	203	203	203	203	203	203	203	203	203
Refrigerant Gas		R134a	R134a	R134a	R134a	R134a	R134a	R134a	R410A	R410A	R410A	R410A	R410A	R410A	R410A	R410A	R410A	R410A	R410A	R410A	R452A	R452A	R452A	R452A
Inlet and Outlet Connections	inches/ DIN	3/4"M	3/4"M	3/4"M	3/4"M	3/4"M	1"F	1"F	1" 1/2F	1" 1/2F	1" 1/2F	1" 1/2F	1" 1/2F	2"F	2"F	2"F	2"F	3"M	3"M	3"M	DN 125	DN 125	DN 125	DN 125
Dimensions	L (mm)	350	350	350	350	350	370	370	460	460	460	580	580	735	735	735	735	1020	1020	1020	1020	1020	1020	1020
	L (inch)	13.8	13.8	13.8	13.8	13.8	14.6	14.6	18.1	18.1	18.1	22.8	22.8	28.9	28.9	28.9	28.9	40.2	40.2	40.2	40.2	40.2	40.2	40.2
	W (mm)	493	493	493	493	493	498	498	558	558	558	588	588	898	898	898	898	1083	1083	1083	1121	2099	2099	2099
	W (inch)	19.4	19.4	19.4	19.4	19.4	19.6	19.6	22.0	22.0	22.0	23.1	23.1	35.4	35.4	35.4	35.4	42.6	42.6	42.6	44.1	82.6	82.6	82.6
	H (mm)	450	450	450	450	450	764	764	789	789	789	899	899	962	962	962	962	1526	1526	1526	1526	1535	1535	1535
	H (inch)	17.7	17.7	17.7	17.7	17.7	30.1	30.1	31.1	31.1	31.1	35.4	35.4	37.9	37.9	37.9	37.9	60.1	60.1	60.1	60.1	60.4	60.4	60.4
Weight	kg	19	19	20	25	27	44	44	53	60	65	80	80	128	146	158	165	325	335	350	380	550	600	650
	Lb	41.9	41.9	44.1	55.1	59.5	97.0	97.0	116.8	132.3	143.3	176.4	176.4	282.2	321.9	348.3	363.8	716.5	738.5	771.6	837.8	1212.5	1322.8	1433.0

1. Flow is measured at reference conditions: ambient pressure of 1 Bar(a) and 25°C at operating pressure of 7 bar (g), inlet temperature 35°C .

## Correction factors for ambient temperature

	°C	25	30	35	40	45								
Room temperature	A	1.00	0.92	0.84	0.80	0.74	(AD 10-250)							
		1.00	0.91	0.81	0.72	0.62	(AD 300-3000)							
Operating temperature	B	1.24	1.00	0.82	0.69	0.58	0.45	(AD 10-250)						
		1.00	1.00	0.82	0.69	0.58	0.49	(AD 300-3000)						
Operation pressure	bar	5	6	7	8	9	10	11	12	13	14	15	16	
	C	0.90	0.96	1.00	1.03	1.06	1.08	1.10	1.12	1.13	1.15	1.16	1.15	(AD 10-250)
		0.90	0.97	1.00	1.03	1.05	1.07	1.09	1.11	1.12	-	-	-	(AD 300-3000)

## Anti-corrosion treatment (available for all refrigerant dryers)

### Technical specifications

Coating type	Aluminum pigmented polyurethane
Color	Champagne
Pretreatment	Degreasing
Temperature Range (dry)	-20 to 150°C (-4° to 302°F)
Substrates	Aluminum and Copper
ASTM B117	4000+ hours(neutral-salt spray test)
Kesternich (2.0 ltr SO <sub>2</sub> )	80 cycles
Layer Thickness	25-30 µm (1 mil)
UV Resistance	Excellent
Adhesion (cross hatch)	0 (European) 5b (USA)
Chemical Resistance	Excellent

### Coating resistance of some typical corrosive gas vapors (based on exposure temperature of 20°C/68°F) – maximum concentrations

Chlorine	64 ppm	Ethanol	320 ppm
Ammonia	160 ppm	Sulphuric acid	320 ppm
Phosphoric acid	320 ppm	Seawater	640 ppm

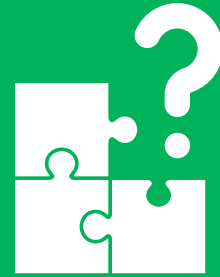
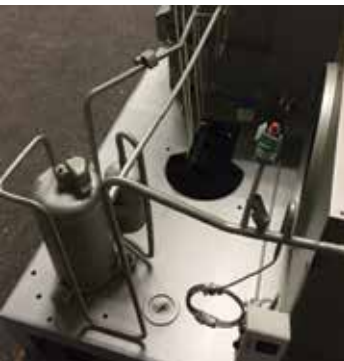

### Problem

Refrigerant dryers can be subjected to severe corrosion when placed in environments rich of e.g ammonia and sulfurs, or close to the seaside. In these cases incompatible metals like copper will be affected since the condenser-fan is blowing a high volume of polluted air through the dryer. Corrosion and pollution of condensers will directly impact the dryer performance. Corrosion can even lead to leaks in the condenser and refrigeration piping.

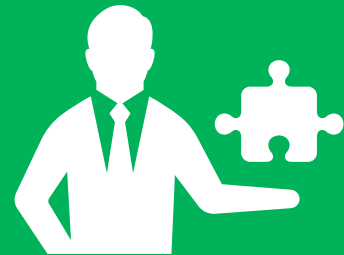

### Solution

Pneumatech offers a long-lasting corrosion protection to the condenser and the refrigerant piping without affecting heat transfer and pressure drop. The heat conductive pigmentation in the coating is oriented in such a way that it creates a very high chemical resistance at a low layer thickness. Therefore it is considered the best available option to prevent refrigeration dryer failure and unnecessary energy consumption.



# AC 15 - 600 - Cycling refrigeration dryers

## Features & Benefits

- ▶ Premium energy efficiency
  - Energy-saving & flow control: adapt energy consumption to the real load
  - Lowest pressure drop over heat exchanger and air piping
  - Zero-loss drains
- ▶ Strong performance & reliability
  - Stable pressure dew point as low as 3°C
  - Guaranteed drying performance in wide range of ambient temperatures
- ▶ Optimal control and monitoring
  - Energy-saving control
  - Voltage-free contact for remote alarm
  - Auto-restart after voltage-failure
  - Communication via industrial protocols like Modbus, Profibus or Ethernet/IP (for AC250-600 only)
- ▶ Easy installation and maintenance at low cost
  - Pipe connections on top
  - Long service intervals
  - Easy access to key components

## General Specifications

- ▶ AC refrigeration dryers: cycling type
- ▶ Operating pressure: 4-16 barg/58-232 psig (4-14 barg/58-189 psig from AC 125 onwards)
- ▶ Max. inlet temperature: 60°C/140°F
- ▶ Flow rate : 22-1026 m<sup>3</sup>/hr (13-604 cfm)<sup>(1)</sup>
- ▶ Pressure dew point: 3°C/37°F (ISO 8573-1:2010 class 4)
- ▶ Power supply: 115/230VAC 50/60 Hz
- ▶ Refrigerant: R134a (AC 15-100), R410a (AC 125-600)



## Options



**Integrated high efficiency line filters**



**Electric panel protection IP 54**

<sup>1</sup>Flow is measured at reference conditions: ambient pressure of 1 bara and 25°C at operating pressure of 7 barg, inlet temperature 35°C .





Pneumatech's AC range offers premium refrigeration drying technology at the lowest operational costs. All AC dryers are equipped with our proprietary energy saving algorithm, which adapts the energy consumption to the real load by continuously monitoring the ambient temperature and the pressure dewpoint. In this way, the risk of downstream corrosion is reduced to zero at all times. When there is less cooling needed, the refrigerant compressor stops and power consumption is significantly reduced, with savings up to 50%.

AC250-600 dryers are also equipped with a flow switch which detects whether there is flow going through the dryer; and shuts down the refrigerant compressor when there is no flow

(even if the energy saving algorithm would not be activated). To make these energy saving functionalities work, the AC range makes use of advanced controllers, which communicate through voltage-free contacts (for AC15-200) or industrial protocols like Modbus, Profibus or Ethernet/IP (for AC250-600).

Premium energy efficiency is also guaranteed thanks to low pressure drops over the heat exchangers, zero-loss drains and our winning combination: rotary compressors and R410A refrigerant on AC125-600. This combination is up to 30% more energy efficient, requires 19% less refrigerant gas and is 100% compliant with European regulation EU No 517 / 2014.

Technical specifications for AC 15-600 50Hz Aircooled																		
Pneumatech Variant → Specifications ↓	Units	AC-15	AC-20	AC-30	AC-40	AC-50	AC-65	AC-85	AC-100	AC-125	AC-150	AC-200	AC-250	AC-300	AC-350	AC-450	AC-500	AC-600
Flow <sup>1)</sup>	l/s	6	10	15	20	25	30	40	50	60	70	95	120	150	185	220	245	285
	m <sup>3</sup> /hr	22	36	54	72	90	108	144	180	216	252	342	432	540	666	792	882	1026
Power consumption	kW	0.2	0.2	0.33	0.41	0.41	0.41	0.6	0.5	0.7	0.7	0.89	1	1	1.4	1.9	1.9	2.2
	hp	0.27	0.27	0.44	0.55	0.55	0.55	0.80	0.67	0.94	0.94	1.19	1.34	1.34	1.88	2.55	2.55	2.95
Pressure drop over dryer	barg	0.07	0.11	0.12	0.12	0.17	0.25	0.2	0.2	0.21	0.28	0.25	0.11	0.15	0.22	0.12	0.18	0.22
	psig	1.02	1.60	1.74	1.74	2.47	3.63	2.90	2.90	3.05	4.06	3.63	1.59	2.18	3.19	1.74	2.61	3.19
Refrigerant type		R134a	R134a	R134a	R134a	R134a	R134a	R134a	R134a	R410A	R410A	R410A	R410A	R410A	R410A	R410A	R410A	R410A
Dimensions	L (mm)	496	496	496	496	496	496	716	716	792	792	792	882	882	948	948	948	948
	L (inch)	19.5	19.5	19.5	19.5	19.5	19.5	28.2	28.2	31.2	31.2	31.2	34.7	34.7	37.3	37.3	37.3	37.3
	W (mm)	377	377	377	377	377	377	380	380	500	500	500	661	661	802	802	802	802
	W (inch)	14.8	14.8	14.8	14.8	14.8	14.8	15.0	15.0	19.7	19.7	19.7	26.0	26.0	31.6	31.6	31.6	31.6
	H (mm)	461	461	461	461	461	461	676	676	680	680	680	1015	1015	1026	1026	1026	1026
	H (inch)	18.1	18.1	18.1	18.1	18.1	18.1	26.6	26.6	26.8	26.8	26.8	40.0	40.0	40.4	40.4	40.4	40.4
Inlet and Outlet Connections		ISO7-R3/4"(m)	ISO7-R3/4"(m)	ISO7-R3/4"(m)	ISO7-R3/4"(m)	ISO7-R3/4"(m)	ISO7-R3/4"(m)	ISO7-R1"(m)	ISO7-R1"(m)	ISO7-R1"(m)	ISO7-R1"(m)	ISO7-R1"(m)	ISO7-R1 1/2"(m)	ISO7-R1 1/2"(m)	ISO7-R2 1/2"(m)	ISO7-R2 1/2"(m)	ISO7-R2 1/2"(m)	ISO7-R2 1/2"(m)
Weight	kg	27	27	32	34	34	34	56	57	82.4	82.4	109.4	170	170	185	197	197	197
	lbs	60	60	71	75	75	75	123	126	182	182	241	375	375	408	434	434	434

1. Flow is measured at reference conditions: ambient pressure of 1 bara and 25°C at operating pressure of 7 barg, inlet temperature 35°C .

K1 Flow correction factors due to compressed air inlet temperature and/or pressure dewpoint (PDP) - 50Hz units										
Temperature	°C	25	30	35	40	45	50	55	60	
	°F	77	86	95	104	113	122	131	140	
PDP	3°C / 37°F	1,2	1,1	1	0,85	0,72	0,6	0,49	0,37	
	5°C / 41°F	1,35	1,23	1,11	0,94	0,8	0,67	0,55	0,42	
	7°C / 45°F	1,5	1,35	1,22	1,02	0,88	0,75	0,61	0,47	
	10°C / 50°F	1,72	1,54	1,38	1,15	1	0,86	0,7	0,54	
	15°C / 59°F	2,11	1,89	1,68	1,43	1,23	1,03	0,83	0,62	

K1 Flow correction factors due to compressed air inlet temperature and/or pressure dewpoint (PDP) - 60Hz units										
Temperature	°C	25	30	35	38	45	50	55	60	
	°F	77	86	95	100	113	122	131	140	
PDP	4°C / 39°F	1,14	1,09	1,03	1	0,8	0,67	0,53	0,4	
	7°C / 45°F	1,27	1,22	1,14	1,09	0,88	0,74	0,59	0,44	
	10°C / 50°F	1,4	1,35	1,24	1,18	0,96	0,8	0,65	0,49	
	15°C / 59°F	1,63	1,55	1,41	1,32	1,08	0,91	0,74	0,56	

K2 Flow correction factors due to compressed air inlet pressure (g)										
Air inlet pressure	barg	4	5	6	7	8	10	12	14	16
	psig	58	72	87	101	116	145	174	203	232
		0,74	0,84	0,92	1	1,05	1,15	1,25	1,31	1,35

Flow correction factor due to ambient temperature - 50Hz units							
Temperature	°C	25	30	35	40	45	50
	°F	77	86	95	104	113	122
		1,00	0,95	0,88	0,81	0,74	0,67

Flow correction factor due to ambient temperature - 60Hz units							
Temperature	°C	25	30	35	38	45	50
	°F	77	86	95	100	113	122
		1,10	1,06	1,02	1,00	0,93	0,88

# AC 650 - 2100 - Large cycling refrigeration dryers (including VSD solutions)

## Features & Benefits

- ▶ Premium energy efficiency
  - Energy-saving & flow control: adapt energy consumption to the real load
  - Variable speed range: exact match between energy consumption and actual demand (available for AC 1600-2100)
  - Lowest pressure drop over heat exchanger and air piping
  - Zero-loss drains
- ▶ Strong performance & reliability
  - Stable pressure dew point as low as 3°C
  - Rotary refrigerant compressors: limited mechanical load & low vibrations
  - Guaranteed drying performance in wide range of ambient temperatures
  - Refrigeration cycle optimized in all conditions thanks to automatic expansion valve & electronic hot gas bypass valve
- ▶ Air-cooled as well as water-cooled versions available
- ▶ Optimal control and monitoring thanks to the Purelogic™ controller
  - Communication via industrial protocols like Modbus, Profibus or Ethernet/IP
  - Internet-based visualization
- ▶ Easy maintenance at low cost
  - Pipe connections on top
  - Long service intervals
  - Easy access to key components

## General Specifications

- ▶ AC refrigeration dryers: cycling type including VSD option (only for AC 1600-2100)
- ▶ Operating Pressure: 4-14 barg/58-189 psig
- ▶ Max. temperature: 50°C/122°F
- ▶ Flow rate: 1116-3636 m³/hr (657-2141 cfm)<sup>(1)</sup>
- ▶ Pressure dew point: 3°C/37°F
- ▶ Power supply: 400V/50Hz; 380V/60Hz; 400-460V/60Hz
- ▶ Refrigerant: R410a
- ▶ Cooling type: Air-cooled and water-cooled



## Options



**IP 54 protection**  
(only for 650-1050;  
standard on AC1250-2100)

<sup>1</sup> Flow is measured at reference conditions: ambient pressure of 1 bara and 25°C at operating pressure of 7 barg, inlet temperature 35°C .

K1 Flow correction factors due to compressed air inlet temperature and/or pressure dewpoint (PDP) - 50Hz units

Temperature	°C	25	30	35	40	45	50	55	60
	°F	77	86	95	104	113	122	131	140
PDP	3°C 37°F	1,2	1,1	1	0,85	0,72	0,6	0,49	0,37
	5°C 41°F	1,35	1,23	1,11	0,94	0,8	0,67	0,55	0,42
	7°C 45°F	1,5	1,35	1,22	1,02	0,88	0,75	0,61	0,47
	10°C 50°F	1,72	1,54	1,38	1,15	1	0,86	0,7	0,54
	15°C 59°F	2,11	1,89	1,68	1,43	1,23	1,03	0,83	0,62

K1 Flow correction factors due to compressed air inlet temperature and/or pressure dewpoint (PDP) - 60Hz units

Temperature	°C	25	30	35	38	45	50	55	60
	°F	77	86	95	100	113	122	131	140
PDP	4°C 39°F	1,14	1,09	1,03	1	0,8	0,67	0,53	0,4
	7°C 45°F	1,27	1,22	1,14	1,09	0,88	0,74	0,59	0,44
	10°C 50°F	1,4	1,35	1,24	1,18	0,96	0,8	0,65	0,49
	15°C 59°F	1,63	1,55	1,41	1,32	1,08	0,91	0,74	0,56

K2 Flow correction factor due to compressed air inlet pressure (g)

Air inlet pressure	barg	4	5	6	7	8	10	12	14
	psig	58	72	87	101	116	145	174	203
		0,74	0,84	0,92	1	1,05	1,15	1,25	1,31

Flow correction factor due to ambient temperature or cooling water temperature - 50Hz units

Temperature	°C	25	30	35	40	45	50
	°F	77	86	95	104	113	122
		1,00	0,95	0,88	0,81	0,74	0,67

Flow correction factor due to ambient temperature or cooling water temperature - 60Hz units

Temperature	°C	25	30	35	38	45	50
	°F	77	86	95	100	113	122
		1,10	1,06	1,02	1,00	0,93	0,88



AC 650-2100 is Pneumatech's premium refrigeration dryer range at higher flows: from 1120 up to 3636 m<sup>3</sup>/hr (657-2141 cfm).

As in the small AC range, operating costs are significantly reduced thanks to the energy saving and flow switch algorithms, the zero-loss drains, the low pressure drop over the heat exchangers and the combination of rotary compressors and R410A refrigerant. The refrigeration cycle is further optimized in all working conditions by making use of the automatic expansion valve & electronic hot gas bypass valve.

From AC 650 onwards, dedicated variable speed (VSD) variants have been added to the range. The VSD controller incorporated

in these dryers matches the energy consumption to the actual compressed air demand. This reduces energy used by as much as 70%, compared to conventional dryers. It works by varying the speed of the compressor, hereby ensuring a stable dew point.

The Purelogic™ is installed as standard on all dryers: it ensures maximum reliability by monitoring the most important parameters of the dryer and offers impressive control and monitoring capabilities, like internet-based visualization.

The entire range is available in both air-cooled and water-cooled versions.

Technical specifications AC 650-2100 fixed speed															
		Air Cooled							Water Cooled						
Pneumatech Variant → Specifications ↓	Units	AC 650	AC850	AC 1050	AC 1250	AC 1600	AC 1800	AC 2100	AC 650	AC 850	AC 1050	AC 1250	AC 1600	AC1800	AC2100
Flow <sup>(1)</sup>	l/s	310	410	510	610	760	870	1010	310	410	510	610	760	870	1010
	m <sup>3</sup> /hr	1116	1476	1836	2196	2736	3132	3636	1116	1476	1836	2196	2736	3132	3636
Power consumption	kW	2.80	3	4.5	4.8	5.3	6.6	7.4	2.00	2.4	4.1	3.1	3.6	4.5	5.1
	hp	3.75	4.02	6.03	6.44	7.11	8.85	9.92	2.68	3.22	5.50	4.16	4.83	6.03	6.84
Pressure drop over dryer	mbar	230	210	200	170	170	140	170	230	210	200	170	170	140	170
	psi	3.3	3.0	2.9	2.5	2.5	2.0	2.5	3.3	3.0	2.9	2.5	2.5	2.0	2.5
Refrigerant type		R410A	R410A	R410A	R410A	R410A	R410A	R410A	R410A	R410A	R410A	R410A	R410A	R410A	R410A
Dimensions	L (mm)	1263	1263	1525	1040	1245	1245	1580	1263	1263	1263	1245	1580	1245	1245
	L (inch)	49.7	49.7	60.0	40.9	49.0	49.0	62.2	49.7	49.7	49.7	49.0	62.2	49.0	49.0
	W (mm)	850	850	850	1060	1060	1060	1060	850	850	850	1060	1060	1060	1060
	W (inch)	33.5	33.5	33.5	41.7	41.7	41.7	41.7	33.5	33.5	33.5	41.7	41.7	41.7	41.7
	H (mm)	1190	1375	1580	1580	1580	1580	1580	1190	1375	1375	1580	1580	1580	1580
	H (inch)	46.9	54.1	62.2	62.2	62.2	62.2	62.2	46.9	54.1	54.1	62.2	62.2	62.2	62.2
Inlet and Outlet Connections		G3"	G3"	G3"	DN100	DN100	DN150	DN150	G3"	G3"	G3"	DN100	DN150	DN150	DN150
Weight	kg	200	245	310	320	380	400	460	180	245	265	350	360	370	380
	lbs	441	540	683	705	838	882	1014	397	540	584	772	794	816	838

Technical specifications AC 650-2100 VSD													
		Air Cooled						Water Cooled					
Pneumatech Variant → Specifications ↓	Units	AC 650 VSD	AC 850 VSD	AC 1050 VSD	AC 1600 VSD	AC 1800 VSD	AC 2100 VSD	AC 650 VSD	AC 850 VSD	AC 1050 VSD	AC 1600 VSD	AC 1800 VSD	AC 2100 VSD
Flow <sup>(1)</sup>	l/s	310	410	510	760	870	1010	310	410	510	760	870	1010
	m <sup>3</sup> /hr	1116	1476	1836	2736	3132	3636	1116	1476	1836	2736	3132	3636
Power consumption	kW	2.28	3.02	3.38	5.3	5.8	6.6	1.48	2.2	2.78	3.3	4.2	5.6
	hp	3.06	4.05	4.53	7.11	7.78	8.85	1.98	2.95	3.73	4.43	5.63	7.51
Pressure drop over dryer	mbar	230	210	200	170	140	170	230	210	200	90	120	170
	psi	3.3	3.0	2.9	2.5	2.0	2.5	3.3	3.0	2.9	1.3	1.7	2.5
Refrigerant type		R410A	R410A	R410A	R410A	R410A	R410A	R410A	R410A	R410A	R410A	R410A	R410A
Dimensions	L (mm)	1263	1263	1263	1245	1245	1580	1263	1263	1263	1580	1580	1580
	L (inch)	49.7	49.7	49.7	49.0	49.0	62.2	49.7	49.7	49.7	62.2	62.2	62.2
	W (mm)	850	850	850	1060	1060	1060	850	850	850	1060	1060	1060
	W (inch)	33.5	33.5	33.5	41.7	41.7	41.7	33.5	33.5	33.5	41.7	41.7	41.7
	H (mm)	1190	1375	1375	1580	1580	1580	1190	1375	1375	1580	1580	1580
	H (inch)	46.9	54.1	54.1	62.2	62.2	62.2	46.9	54.1	54.1	62.2	62.2	62.2
Inlet and Outlet Connections		ISO7-R3*	ISO7-R3*	ISO7-R3*	DN100	DN150	DN150	ISO7-R3*	ISO7-R3*	ISO7-R3*	DN150	DN150	DN150
Weight	kg	218	245	265	380	400	460	200	245	265	410	410	410
	lbs	481	540	584	838	882	1014	441	540	584	904	904	904

\*3 control modes i.e Economy, lowest dewpoint and maximum saving control offer different power consumptions.

# AC 2650 - 8500 - Large cycling refrigeration dryers (including VSD solutions)

## Features & Benefits

- ▶ Stable and guaranteed Performance at all operating conditions - PDP of 3°C thanks to direct expansion technology
- ▶ Lowest pressure drop
- ▶ Advanced control algorithm with three different control modes for variable speed versions:
  - Regulation of the refrigerant compressor based on actual load
  - Economy: PDP = ambient temperature minus 20°C (68°F)
  - Lowest Dew-point: best possible PDP
  - Max. saving: PDP = ambient temperature minus 15°C (59°F)
  - Much better turndown efficiency is achieved when the unit runs in a partial load condition
- ▶ Zero glide refrigerant – R410a: No-temperature-glide effect resulting in stable guaranteed PDP
- ▶ Comprehensive scope of supply:
  - Energy efficient heat exchanger
  - Fully hermetically sealed refrigerant compressor with phase sequence relay
  - Refrigerant filter/dryer (standard on all AC 2650-8500 fixed speed and VSD dryers)
  - Electronic hot gas bypass valve (EHGPV)
  - Purelogic™ for advanced control and monitoring



## Reduced lifecycle costs and faster payback thanks to reduced power consumption

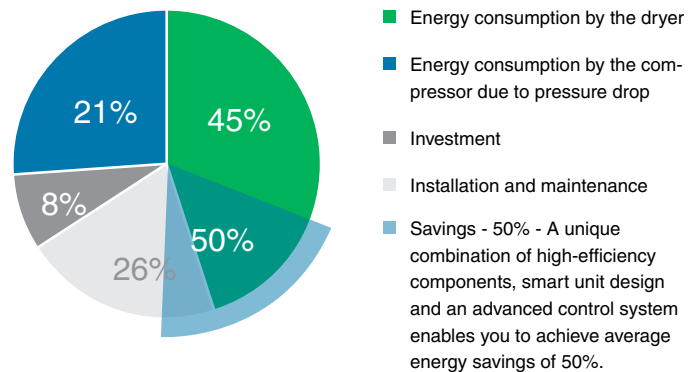

## General Specifications

- AC refrigeration dryers: cycling type including VSD
- Operating Pressure: 4-14 barg/58-189 psig
- Max. Ambient temperature: 40°C/104°F (46°C/115°F as an option)
- Flow rate: 450-14400 m³/hr (2650-8475 cfm)
- Pressure dew point: 3°C/37°F
- Power supply: 400V/50Hz; 380V/60Hz; 400-460V/60Hz
- Refrigerant: R410a
- Cooling type: Air-cooled and water-cooled

## Options

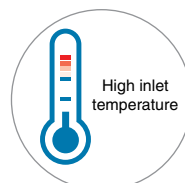

High inlet temperature  
 46°C/115°F ambient temperature version

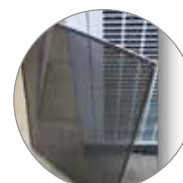

Cooling air pre-filter



Anchor pads



Customized solutions (contact your Pneumatech representative for further information)



AC 2650-8500 FS/VSD is Pneumatech's premium refrigeration dryer range at higher flows: from 4500 up to 14400 m<sup>3</sup>/hr (2650-8475 cfm). AC 2650-8500 (VSD) refrigerant dryers are engineered in house and tested using the most stringent methods (at ambient temperatures up to 46°C/115°F). They exceed the international standards for compressed air purity and are tested according to ISO 7183:2007.

New AC Range is the most efficient dryer for continuous and varying air demand applications. A combination of new innovative technologies integrated in the new AC 2650-8500 (VSD) dryers'

design makes them a perfect match for customers looking for reliable equipment with a low cost of ownership. The unique combination of high efficiency components, a smart unit design and an advanced unit control system gives an opportunity to save on average 50% of the consumed energy.

Significantly reduced power consumption and low quantities of refrigerant make sure the AC 2650-8500 (VSD) dryers operate at the lowest possible carbon footprint

Technical specifications AC 2650-4200 fixed speed									
		Air Cooled				Water Cooled			
Pneumatech Variants → Specifications ↓	Units	AC 2650	AC 3200	AC 3700	AC 4200	AC 2650	AC 3200	AC 3700	AC 4200
Flow <sup>(1)</sup>	l/s	1250	1500	1750	2000	1250	1500	1750	2000
	m <sup>3</sup> /hr	4500	5400	6300	7200	4500	5400	6300	7200
Power consumption	kW	6.80	8.9	10.5	12.2	5.3	5.8	6.4	8.70
	hp	9.12	11.94	14.08	16.36	7.11	7.78	8.58	11.67
Pressure dropover dryer	mBar	180	180	150	190	180	160	150	190
	psi	2.6	2.6	2.2	2.8	2.6	2.3	2.2	2.8
Refrigerant type	kg	R410A	R410A	R410A	R410A	R410A	R410A	R410A	R410A
Dimensions	L (mm)	1474	1474	1474	1474	1474	1474	1474	1474
	L (inch)	58.0	58.0	58.0	58.0	58.0	58.0	58.0	58.0
	W (mm)	1579	1579	1579	1579	1579	1579	1579	1579
	W (inch)	62.2	62.2	62.2	62.2	62.2	62.2	62.2	62.2
	H (mm)	2295	2295	2295	2295	1725	1725	1725	1725
	H (inch)	90.4	90.4	90.4	90.4	67.9	67.9	67.9	67.9
Inlet and Outlet Connections		DN150	DN150	DN150	DN150	DN150	DN150	DN150	DN150
Weight	kg	835	865	910	950	775	800	845	850
	lbs	1841	1907	2006	2094	1709	1764	1863	1874

Technical specifications AC 2650-8500 VSD															
		Air Cooled							Water Cooled						
Pneumatech Variants → Specifications ↓	Units	AC 2650 VSD	AC 3200 VSD	AC 3700 VSD	AC 4200 VSD	AC 5100 VSD	AC 6400 VSD	AC 8500 VSD	AC 2650 VSD	AC 3200 VSD	AC 3700 VSD	AC 4200 VSD	AC 5100 VSD	AC 6400 VSD	AC 8500 VSD
Flow <sup>(1)</sup>	l/s	1250	1500	1750	2000	2400	3000	4000	1250	1500	1750	2000	2400	3000	4000
	m <sup>3</sup> /hr	4500	5400	6300	7200	8640	10800	14400	4500	5400	6300	7200	8640	10800	14400
Power consumption	kW	5.50	7.4	8.4	8.8	6.4	12.8	18.7	4.4	5.1	6.1	6.7	5.5	10.6	14.5
	hp	7.38	9.92	11.26	11.80	8.58	17.17	25.08	5.90	6.84	8.18	8.98	7.38	14.21	19.44
Pressure drop over dryer	mBar	180	180	150	190	270	190	190	180	180	150	190	270	190	190
	psi	2.6	2.6	2.2	2.8	3.9	2.8	2.8	2.6	2.6	2.2	2.8	3.9	2.8	2.8
Refrigerant type		R410A	R410A	R410A	R410A	R410A	R410A	R410A	R410A	R410A	R410A	R410A	R410A	R410A	R410A
Dimensions	L (mm)	1474	1474	1474	1474	1474	2502	2502	1474	1474	1474	1474	1474	2502	2502
	L (inch)	58.0	58.0	58.0	58.0	58.0	98.5	98.5	58.0	58.0	58.0	58.0	58.0	98.5	98.5
	W (mm)	1579	1579	1579	1579	1579	1579	1579	1579	1579	1579	1579	1579	1579	1579
	W (inch)	62.2	62.2	62.2	62.2	62.2	62.2	62.2	62.2	62.2	62.2	62.2	62.2	62.2	62.2
	H (mm)	2295	2295	2295	2295	2295	2295	2295	2295	1725	1725	1725	1725	1725	1736
	H (inch)	90.4	90.4	90.4	90.4	90.4	90.4	90.4	67.9	67.9	67.9	67.9	67.9	67.9	68.3
Inlet and Outlet Connections		DN150	DN150	DN150	DN150	DN150	DN200	DN200	DN150	DN150	DN150	DN150	DN150	DN200	DN200
Weight	kg	850	880	920	965	990	1690	1820	800	815	855	865	870	1410	1540
	lbs	1874	1940	2028	2127	2183	3726	4012	1764	1797	1885	1907	1918	3109	3395

\*3 control modes i.e Economy, lowest dewpoint and maximum saving control offer different power consumptions.

## **Do not ‘over-dry’ your entire compressed air network**

Dry air comes with a cost, both in terms of initial investment as well as running costs. The required dryness should be chosen based on the largest compressed air consumers, while more critical applications can be covered with a low PDP dryer at point-of-use.

So before you install a centralized adsorption dryer, verify whether such high degree of dryness is required for your entire system. It could be sufficient to install a centralized refrigeration dryer, and to place a small adsorption or membrane dryer at point-of-use for critical applications.



# Membrane Dryers

Because they are not powered by electricity, membrane dryers function safely in environments that must be explosion proof such as laboratories. Thanks to their quiet operation, membrane dryers can be used close to the workplace.

Pneumatech offers a range of 5 models for low flow applications.

## M POU 2 - 16 - Point-of-use membrane dryers

### Features and Benefits

- ▶ No power source needed
- ▶ Simple yet eco-friendly technology
  - No desiccants or refrigerants used for drying
  - No condensate drains
- ▶ Guaranteed performance
  - High water vapor selectivity thanks to non-porous membrane
  - No penetration of gases other than moisture
- ▶ Maintenance free
  - No wear and tear of any mechanical or electrical part
  - No need of replacement of any component
- ▶ Easy to transport and install
  - Built-in purging circuits
  - Easy and simple dew point adjustments thanks to the purge low control

### General Specifications

- ▶ Dew points achievable: up to  $-40^{\circ}\text{C}/-40^{\circ}\text{F}$ 
  - Note: only energy-efficient up to pressure dew point reductions of  $30^{\circ}\text{C}/86^{\circ}\text{F}$
- ▶ Operating pressure range:  
0 - 8.5 barg/0-120 psig
- ▶ Operating temperature range:  
 $-20^{\circ} - 55^{\circ}\text{C} / -4^{\circ} - 131^{\circ}\text{F}$
- ▶ Ambient temperature range:  
 $-20^{\circ} - 55^{\circ}\text{C} / -4^{\circ} - 131^{\circ}\text{F}$



### Applications



Dehumidified  
sampling gases for  
gas analysers



Laser  
machining tool



Paper industry



EDM tools



Food and  
beverages



Gas  
generators





Pneumatech offers an easy-to-use and simple drying solution for small compressed air needs. Pneumatech's point-of-use membrane dryer does not require any power source, is compact and easy to install. This makes the dryer suitable for various smaller compressed air applications where a higher degree of dehumidification is required, such as laser machining tools, precision measuring equipment, gas analyzers and small gas generators.

can go down to -40°C/-40°F. This is achieved by a hollow-fiber membrane, where moisture can diffuse through the fine pores of the fiber bundles. When differences in moisture concentration arise between the inside and outside of a fiber membrane, moisture is transferred through the membrane surface to equalize the moisture concentration on both sides of the membrane. Part of the dry air is used as purge air in order to remove the moisture from the incoming wet air.

The pressure dew point achieved by membrane dryers is dependent on the inlet temperature of the compressed air; but

Technical specifications for M POU 2-16							
Product → Specification ↓	Unit		M POU 2	M POU 3	M POU 5	M POU 11	M POU 16
Nominal volume flow at dryer inlet <sup>(1)</sup>	l/s		0,83	1,33	2,50	5,00	7,50
	m <sup>3</sup> /hr		3	4,8	9	18	27
Supply Gas Inlet and outlet connections	Inlet (G/NPT)		1/8"	1/8"	1/4"	3/8"	3/8"
	Outlet (G/NPT)		1/4"	1/4"	1/4"	1/4"	1/4"
Weight	Kg		0,27	0,27	0,34	0,68	0,72
	Lb		0,59	0,6	0,76	1,5	1,59
Dimensions	Width	mm	61	61	70	100	100
		inch	2,4	2,4	2,8	3,9	3,9
	Height	mm	112	112	153	200	200
		inch	4,4	4,4	6,0	7,9	7,9
	Length	mm	31	31	40	50	50
		inch	1,2	1,2	1,6	2,0	2,0

1. Flow is measured at Reference Conditions: 1 bara and 20°C at operating pressure of 7 barg, inlet temperature 35°C & 30°C dew point reduction on inlet temperature..

## Certified performance

Pneumatech filters have been fully tested and qualified according to the latest ISO standards. Tests have been conducted in-house as well as in external labs, and are independently validated by TÜV. The following table shows some of our available ISO certificates.

The ISO 8573 standards deal with the measurement of compressed air purity, while the ISO 12500 series validate the test methods for compressed air equipment.

ISO standard	Test method for	Available for
ISO 8573-2:2018	Oil aerosol content	G/C
ISO 12500-1:2007	Oil aerosol filters	
ISO 8573-5:2001	Oil vapor content	VT
ISO 12500-2:2007	Oil vapor filters	
ISO 8573-4:2019	Solid particle content	S/D G/C
ISO 12500-3:2009	Solid particle filters	



# Filter Solutions

Pneumatech offers you a comprehensive line-up of innovative filter solutions to meet your specific needs. Our filtration solutions are engineered cost-effectively to provide the best air quality and meet today's increasing quality demands.

For general applications we provide oil coalescing, particulate and oil vapor filters in a wide range of flows and pressures. Pneumatech is also your partner for breathing air, silicone-free, sterile & process filtration.

# Ultimate water separators

## Features & Benefits

- ▶ Energy saving
  - Reducing both energy consumption and operating costs
- ▶ Flexible Installation
  - Modular design and accessible fixings enable simple close coupling assembly
- ▶ Cost effective
  - No replacement components required
- ▶ Product safety in mind
  - Guaranteed safe housing closure with rotational safety stop
- ▶ Corrosion protection
  - Internal and external electrophoretic painting followed by a tough polyester powder coating

## General Specifications

- ▶ 13 sizes from 10-2550 m<sup>3</sup>/h
- ▶ Proven centrifugal technology
- ▶ Unique module with unique vanes to eliminate points of low efficiency
- ▶ Eliminates 99% bulk water, even at low velocities
- ▶ Minimal operating pressure loss (50-60 mbar)
- ▶ No replacement components necessary
- ▶ External accessible drain valve
- ▶ Same installation accessories as the filter series
- ▶ Electronic drain available as an option



## Options



Electronic drain



Wall brackets



Integrating into Pneumatech's compressed air filtration range, the new Ultimate Water Separator combines proven centrifugal technology with a new forward thinking housing design to deliver market leading water removal efficiencies – eliminating 99% bulk water with continuously low differential pressure.

The custom engineered centrifugal module features unique vanes to eliminate points of low efficiency, and a vortex arrestor to stop re-entrainment – ensuring minimal operating pressure loss and maintaining excellent liquid removal, even at low velocity. Remove 99% of bulk water when tested in accordance with ISO 12500-4

## Tested performance

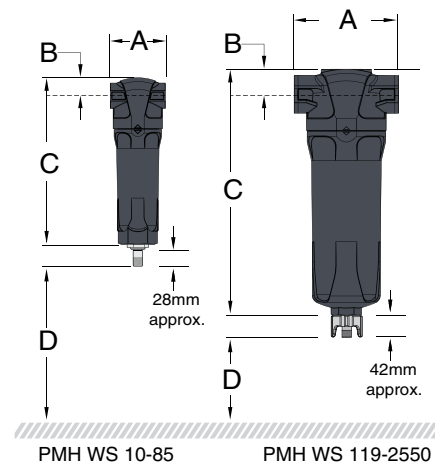
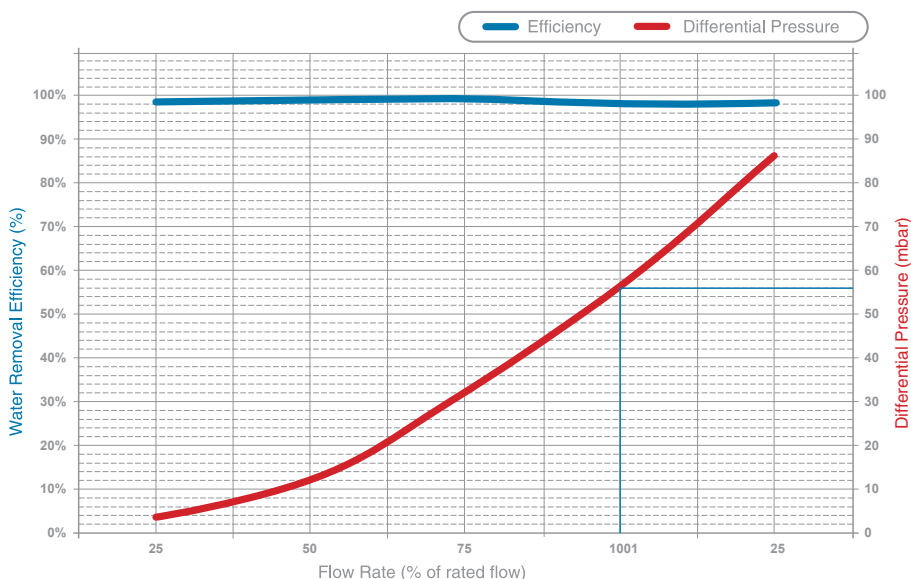

With exceptional performance at any flow rate, the new Ultimate water separator is perfect for use with variable speed compressors.

Filter Model	Pipe Size	Flow Rate		Dimension (mm)				Weight (Kg) Approx.	Element Model
		Nm <sup>3</sup> /h	SCFM	A	B	C	D		
PMH WS 10	1/8"	10	6	50	17	157	60	0.25	-
PMH WS 25	1/4"	25	15	50	17	157	60	0.25	-
PMH WS 42	1/4"	42	25	70	24	231	70	0.6	-
PMH WS 59	3/8"	59	35	70	24	231	70	0.6	-
PMH WS 85	1/2"	85	50	70	24	231	70	0.6	-
PMH WS 119	1/2"	119	70	127	32	285	80	1.7	-
PMH WS 212	3/4"	212	125	127	32	285	80	1.7	-
PMH WS 297	1"	297	175	127	32	285	80	1.7	-
PMH WS 476	1 1/4"	476	280	140	40	475	80	3	-
PMH WS 545	1 1/2"	545	321	140	40	475	80	3	-
PMH WS 1189	2"	1189	700	170	53	508	100	4.9	-
PMH WS 1444	2 1/2"	1444	850	220	70	413	100	8	-
PMH WS 2550	3"	2550	1500	220	70	413	100	8	-

## Ultimate filters - Threaded filters

### Features & Benefits

- ▶ Flow-optimised design
- ▶ Improved air flow characteristics
- ▶ Reduced energy consumption
- ▶ Reduced costs of owner ship
- ▶ 6 filtration grades
- ▶ Increased performance
  - Significantly reduced differential pressure <125 mbar
  - Exceptional oil aerosol and particulate removal
- ▶ New filtration technology
  - NEW deep pleated media
  - NEW housing design for flexible installation and simplified serviceability
  - NEW externally accessible drain
- ▶ Tested and validated in accordance with ISO 12500-1 & ISO 8573-1:2010
- ▶ Dead stop head to bowl connection with lock indication for safety closure
- ▶ Corrosion protected housings: internal and external electrophoretic paint finish followed by a tough polyester powder coating
- ▶ Unique, specially designed adapter for removal of the automatic and manual drains from the bowl without a need to open the filter (for sizes 119-2550 m<sup>3</sup>/h)
- ▶ Multiple options
  - Differential pressure gauge with/without potential free contact
  - Manual drain
  - Automatic drain
  - Electronic drain
  - Wall brackets
  - Connection kits

### General Specifications

- ▶ Significantly reduced differential pressure <125 mbar
- ▶ Maximum working pressure: 16 bar(g)/232 psi(g)
- ▶ With manual drain: up to 20.7 bar(g)/300 psi(g)
- ▶ Available from 1/8" to 3"
- ▶ Flow rates from 10-2550 Nm<sup>3</sup>/h (6-1500 scfm)



### Options



Connection kits



Automatic drain



Wall brackets



Manual drain with adapter



Electronic drain



Differential pressure gauge including potential free contact



With energy efficiency and low total cost of ownership the Pneumatech Ultimate Filter surpasses conventional filters in the market place, providing to be the most advanced filter yet.

with the new element design, significantly improves air flow and performance, making the Ultimate filter one of the most energy efficient filter housings available.

The expertly engineered Ultimate Series not only achieves the highest air purity standards in line with ISO 8573-1:2010, it also incorporates the latest in filtration technology. The new filter housing reduces differential pressure loss which, when combined

With a range that incorporates coalescence filters, dust filters, activated carbon filters and water separators, available in a wide range of port sizes suitable for installation worldwide.

Filter Model	Pipe Size	Flow Rate		Dimension (mm)				Weight (Kg) Approx.	Element Model
		Nm <sup>3</sup> /h	SCFM	A	B	C	D		
PMH (grade) 10	1/8"	10	6	50	17	157	60	0.25	F(grade)-1
PMH (grade) 25	1/4"	25	15	50	17	157	60	0.25	F(grade)-2
PMH (grade) 42	1/4"	42	25	70	24	231	70	0.6	F(grade)-3
PMH (grade) 54	3/8"	54	32	70	24	231	70	0.6	F(grade)-4
PMH (grade) 85	1/2"	85	50	70	24	231	70	0.6	F(grade)-5
PMH (grade) 119	1/2"	119	70	127	32	285	80	1.7	F(grade)-6
PMH (grade) 144	3/4"	144	85	127	32	285	80	1.7	F(grade)-7
PMH (grade) 178	1"	178	105	127	32	285	80	1.7	F(grade)-8
PMH (grade) 212	3/4"	212	125	127	32	371	80	2	F(grade)-9
PMH (grade) 297	1"	297	175	127	32	371	80	2	F(grade)-10
PMH (grade) 476	1 1/4"	476	280	140	40	475	80	3	F(grade)-11
PMH (grade) 545	1 1/2"	545	321	140	40	475	80	3	F(grade)-12
PMH (grade) 765	2"	765	450	170	53	508	100	4.9	F(grade)-13
PMH (grade) 1189	2"	1189	700	170	53	708	100	5.5	F(grade)-14
PMH (grade) 1444	2 1/2"	1444	850	220	70	736	100	10.5	F(grade)-15
PMH (grade) 1529	3"	1529	900	220	70	736	100	10.5	F(grade)-16
PMH (grade) 2125	3"	2125	1250	220	70	857	100	11.5	F(grade)-17
PMH (grade) 2550	3"	2550	1500	220	70	1005	100	12.5	F(grade)-18

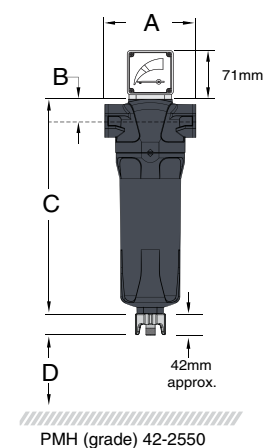
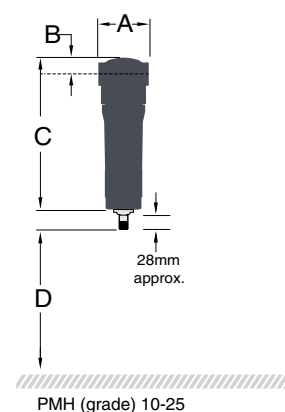

Grade	P	G	S	C	D	V
Particle removal (micron) ■	5	-	1	-	0.01	-
Outlet oil aerosol concentration (mg/m <sup>3</sup> ) ■	1	0.3	-	0.01	-	0.003
Total mass efficiency (%)	>90	>99.25	-	>99.9	-	-
Quality class of air at outlet (particles / oil) ▲	4 / 3	- / 3	3 / -	- / 2	1 / -	- / 1
Initial pressure drop over filter in dry applications (bar)	0.05	0.055	0.055	0.085	0.085	0.115
Initial pressure drop over filter in wet applications (bar) ★	0.08	0.125	-	0.125	-	-

### Pressure correction factors

For maximum flow rate, multiply model flow rate by the correction factor corresponding to the minimum operating pressure

Operating pressure barg (psig)	4 (58)	5 (72)	6 (87)	7 (100)	8 (115)	10 (145)	12 (174)	14 (203)	16 (232)	20 (290)
7 barg – correction factor	0.76	0.84	0.92	1.00	1.07	1.19	1.31	1.41	1.51	1.6



# Ultimate filters - Elements

## Features & Benefits

- ▶ Push fit Pneumatech filtration
- ▶ High quality stainless steel cylinders
- ▶ Custom engineered
- ▶ Custom outer drainage layer
- ▶ Unique element end cap
- ▶ Piracy protection (from size 3)
- ▶ Color coding system for optimum identification

## General Specifications

- ▶ 6 filtration grades: coalescence, dust & oil vapor filtration



## Market-leading filtration performance

To ensure optimal performance and low cost, filter elements should be replaced with original parts every 12 months/8000 hours (whichever comes first). Activated carbon filter elements should be replaced every 6 months/1000 hours (whichever comes first).

Pneumatech utilizes deep pleated media to deliver market leading filtration performance. The new forward thinking design delivers exceptional results in both oil aerosol removal and particulate retention; significantly reducing differential pressure and energy consumption for low operational lifetime costs. Engineered to

deliver a step change in performance, the new ultimate element optimizes filtration efficiencies and produces compressed air in line with the highest standards of air purity, meeting the quality classes specified in ISO 8573-1: 2010.

## Performance assured

### Filter housing design

The ISO 8573 group of international standards is used for the classification of compressed air

- ▶ 1000 hour neutral salt spray test for corrosion to ISO 9227:2006
- ▶ Burst pressure tested in excess of 100 barg for a 5:1 safety factor
- ▶ Housings are pressure decay tested before despatch. Fine filters are 100% aerosol integrity tested

### Element technology

The new series is available in a complete range of contamination removal grades designed to meet the compressed air purity requirements throughout industry

- ▶ ISO 8573-1:2010 compressed air purity standard
- ▶ ISO 12500 series international standard for compressed air filter testing

### Independent validation

Housing are approved to international standards including:

- ▶ Pressure equipment directive 2014/68/EU - Lloyd's register EMEA - notified body no. 0038
- ▶ ISO 9001 quality systems - LRQ0930553 - Lloyd's register EMEA - notified body no. 0038
- ▶ CRN approved - CRNOE19418 - for use within Canada

## Typical installation

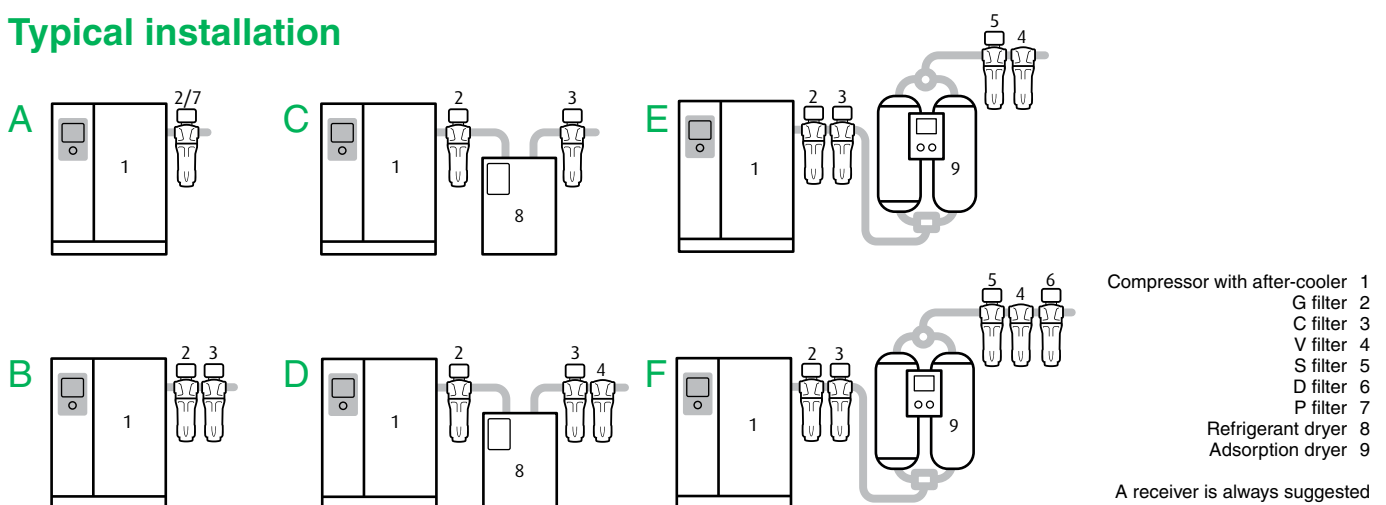

**A.** General purpose protection air purity to ISO 8573-1:2010  
G filter [ 3 : - : 3 ]  
P filter [ 4 : - : 3 ]

**B.** General purpose protection and reduced oil concentration air purity to ISO 8573-1:2010  
[ 1 : - : 2 ]

**C.** High quality air with reduced dew point air purity to ISO 8573-1:2010  
[ 1 : 4 : 2 ]

**D.** High quality air with reduced dew point and oil concentration air purity to ISO 8573-1:2010  
[ 1 : 4 : 1 ]

**E.** High quality air with extremely low dew point air purity to ISO 8573-1:2010  
[ 2 : 2 : 1 ]

**F.** High quality air with extremely low dew point air purity to ISO 8573-1:2010  
[ 1 : 2 : 1 ]

## Ultimate filters - Industries

In any compressed air system, impurities are inevitable. Dust, dirt, water and oil contaminants can reduce air quality and significantly affect system efficiency. However, inadequate or incorrect filtration can negatively impact performance and end user equipment, and cause potential costly system downtime. With over 30 years of experience, Pneumatech has the know-how to support the individual demands of our customers.

**Laser cutting**



**Packaging and bottling**



**Optical industry**



**Automotive**



**Energy**



**Electronic component manufacturing**



**Glass/crystal**



**Gas generation**



**Nuclear plants**



## FF 1 - 12 - Flanged filters

### Features & Benefits

- ▶ Guaranteed air purity
  - High-efficient glass fiber and foam media
- ▶ No risks of:
  - Cracked filter media
  - Cylinder implosion
  - Top cap leakages
  - Oil re-entrainment
- ▶ Significant energy savings
  - Optimal filter media selection allows low pressure losses
  - Zero-loss electronic drain included as standard
- ▶ Highest quality standards
  - In-house research, development & production
  - Each filter subjected to rigorous quality control
  - Fully tested and qualified according to ISO standards
- ▶ Robust design
  - Stainless steel cores guarantee ultimate strength
  - Protection paper to avoid damaging of glass fiber media
  - Special coating ensures high corrosion protection, and therefore a housing lifetime of at least 20 years
- ▶ Easy service and installation
  - Bottom cover with special rotating system
  - Different grade, different colour
  - Differential pressure gauge, with voltage free contact

### General Specifications

- ▶ Compressed air inlet pressure:  
1-16 barg/15-232 psig
- ▶ Max. ambient air temperature:  
66°C/151 °F (35°C/95 °F for V grade)
- ▶ Available grades:
  - P: pre-filter
  - G: fine filter
  - C: super fine filter
  - V: activated carbon filter for oil vapor
  - S: dust filter
  - D: dust filter- high efficient



### Zooming in

#### Special rotating system of bottom cover

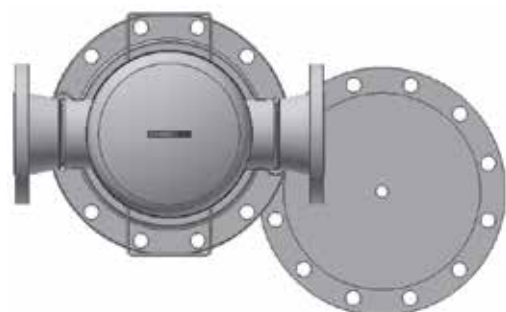



Pneumatech's flanged filter range contains the same type of robust, high-efficient filter cartridges as the threaded range. The cartridges are contained in a welded steel housing which is pressure-rated up to 16 barg / 232 psig and provided with flanged connections at the compressed air inlet and outlet. The filter housings are completely cleaned, zinc phosphate and KTL

coated at the inside and outside and externally painted afterwards. This guarantees a housing lifetime of at least 20 years.

All flanged filters are standard equipped with a zero-loss electronic drain and differential pressure gauge with voltage-free contact connections. The special rotating system of the bottom cover makes filter cartridge replacement very straightforward.

Technical specifications for flanged filters FF 1-12													
Pneumatech Variant → Specifications ↓	Units	FF 1	FF 2	FF 3	FF 4	FF 5	FF 6	FF 7	FF 8	FF 9	FF 10	FF 11	FF12
Nominal (max.) Flow Rate <sup>(1)</sup>	l/s	"550 (630)"	"850 (970)"	1100 (1260)	1400 (1600)	1800 (2200)	2200 (2400)	3000 (3600)	4000	5000	6000	7000	8000
	m <sup>3</sup> /hr	1980 (2268)	3060 (3492)	3960 (4536)	5040 (5760)	6480 (7920)	7920 (8640)	10800 (12960)	14400	18000	21600	25200	28800
	cfm	1165 (1335)	1801 (2055)	2331 (2670)	2966 (3390)	3814 (4662)	4662 (5085)	6357 (7628)	8476	10594	12713	14832	16951
Max Pressure	barg	16	16	16	16	16	16	16	16	16	16	16	16
	psig	232	232	232	232	232	232	232	232	232	232	232	232
Connection	DN	DN80	DN100	DN100	DN150	DN150	DN150	DN200	DN200	DN250	DN250	DN300	DN300
Dimensions (A)	mm	370	510	510	620	640	640	820	820	820	920	920	1040
	inch	14.6	20.1	20.1	24.4	25.2	25.2	32.3	32.3	32.3	36.2	36.2	40.9
Dimensions (B)	mm	190	230	230	290	285	285	400	400	400	550	550	525
	inch	7.5	9.1	9.1	11.4	11.2	11.2	15.7	15.7	15.7	21.7	21.7	20.7
Dimensions (C)	mm	1295	1360	1360	1480	1555	1555	1745	1745	1745	2085	2085	2070
	inch	51.0	53.5	53.5	58.3	61.2	61.2	68.7	68.7	68.7	82.1	82.1	81.5
Weight	Kg	76	141	143	210	176	178	420	428	432	594	597	1140
	Lbs	167.6	310.9	415.3	463	388	392.4	925.9	943.6	952.4	1034	1479.3	1984.2
Number of filter elements		1	3	4	5	6	7	10	14	16	20	24	28
Filter element size		1F (grade)	2F (grade)	2F (grade)	2F (grade)	2F (grade)	2F (grade)	2F (grade)	2F (grade)	2F (grade)	2F (grade)	2F (grade)	2F (grade)
Order example:		FF 1 C HE (superfine filter with differential pressure gauge)											

1. Flow is measured at reference conditions: 1 bara and 20°C at operating pressure of 7 barg, inlet temperature 10°C & std PDP of 3°C at the inlet.

Filter elements performance						
Grades → Performance ↓	P	G	C	V	S	D
	Pre-filter	Fine filter - Oil aerosols/ solid particles	Super fine filter - Oil aerosols/ solid particles	Activated Carbon - Oil vapor	Dust filter	High efficiency dust filter
Particle removal efficiency at nominal flow (% at MPPS)	92.03%	99.92%	99.98%	n/a	99.92%	99.98%
Oil carry-over at nominal flow (mg/m <sup>3</sup> )	<1*	<0,07*	<0,008*	<0,003	n/a	n/a

\* Oil aerosol content

Correction factors												
Inlet pressure (barg)	1	2	3	4	5	6	7	8	10	12	14	16
Inlet pressure (psig)	15	29	44	58	72.5	87	102	116	145	174	203	232
Correction factor	0.38	0.53	0.65	0.75	0.83	0.92	1	1.06	1.2	1.31	1.41	1.5

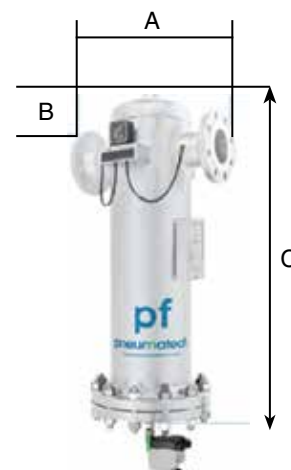



# VT - Activated carbon towers + vessels

## Features & Benefits

- ▶ Guaranteed air purity with residual oil content below 0,003 mg/m<sup>3</sup>
  - Superb 2-layer activated carbon material
  - Designed with sufficient safety margin
  - Performance certified by external body
- ▶ Significant energy savings & limited system operating costs
  - Optimal internal flow path
  - Average pressure drop of 125 mbar only
- ▶ Certified class 1 performance, according to ISO 8573-1:2010
  - If combined with Pneumatech oil coalescing filters (G & C)
- ▶ Compact and reliable product design
  - Wall-mounting kit, optional for VT1 - 7
  - Easy to lift, install and service
- ▶ The VT is capable of removing hydrocarbons, odors and oil vapors from compressed air

## General Specifications

- ▶ Compressed air inlet pressure:
  - VT 1-9: 1-16 barg/15-232 psig (extruded Versions)
  - VT with optional oil indicator: 1-8,8 barg/ 15-127 psig
  - VT 11-15: 1-14,5 barg/15-210 psig (Welded Versions)
  - VT11-15: life time 12000 hours
- ▶ Ambient air temperature: (Extruded Versions)
  - -10 - 50°C/14 - 122°F
- ▶ Ambient air temperature: (Welded Versions)
  - -10 - 80°C/14 - 176°F
- ▶ Compressed air inlet temperature:
  - 1 - 66°C/34 - 151°F



VT 1-9



VT 11-15

## Options



Wall mounting kit



Oil indicator



Oil indicator welded version



Dust filter



ISO 8573-1:2010 Class 1 validation certificate



Pneumatech's VT activated carbon towers and vessels are high-efficiency filtration products designed to meet the most demanding industry applications. Examples are pharmaceutical, medical, food & beverage, electronics and chemical industries.

The VT is capable of removing hydrocarbons, odors and oil vapors from compressed air. The activated carbon layers will, by the use Activated carbon vessels for higher flows available on request. Please consult Pneumatech for further support.

1. Flow is measured at reference conditions: 1 bara and 20°C at operating pressure of 7 barg, inlet temperature 20°C & inlet PDP of 3°C at the outlet. of adsorption, reduce the residual oil content to less than 0,003 mg/m3. In combination with Pneumatech G and C filters, the VT meets the requirements of air purity class 1 for total oil, according to ISO 8573-1:2010 in a typical compressed air installation, as was certified by an external body.

### Technical specifications for VT 1-9

Pneumatech Variant → Specifications ↓	Units	VT 1	VT 2	VT 3	VT 4	VT 5	VT 6	VT 7	VT 8	VT 9
Capacity <sup>(1)</sup>	l/s	20	45	60	95	125	150	185	245	310
	m <sup>3</sup> /hr	72	162	216	342	450	540	666	882	1116
	cfm	42	95	127	201	265	318	392	519	657
Initial pressure drop over filter when dry	BARG	0,015	0,065	0,11	0,085	0,135	0,1	0,145	0,185	0,27
Connection	G/NPT	½"	1"	1"	1"	1½"	1½"	1½"	1½"	1½"
Dimensions (A)	mm	490	715	840	715	840	715	840	840	840
	inch	19.29	28.15	33.07	28.15	33.07	28.15	33.07	33.07	33.07
Dimensions (B)	mm	223	223	223	387	387	551	551	715	879
	inch	8.78	8.78	8.78	15.24	15.24	21.69	21.69	28.15	34.61
Dimensions (C)	mm	190	190	190	190	190	190	190	190	190
	inch	7.48	7.48	7.48	7.48	7.48	7.48	7.48	7.48	7.48
Weight	Kg	10	15	18	29	34	42	50	67	84
	Lbs	22.0	33.1	39.7	63.9	75.0	92.6	110.2	147.7	185.2

1. Flow is measured at reference conditions: 1 bara and 20°C at operating pressure of 7 barg, inlet temperature 20°C & inlet PDP of 3°C at the outlet.

### Technical specifications vessel version VT 11-15

Pneumatech Variant → Specifications ↓	Units	VT 11	VT 12	VT 13	VT 14	VT 15
Capacity	l/s	425	550	850	1100	1800
	m <sup>3</sup> /hr	1530	1980	3060	3960	6480
	cfm	901	1165	1801	2331	3814
Initial pressure drop over filter when dry	bar	0.070	0.080	0.095	0.095	0,120
Connection	DIN	80	80	100	100	150
Dimensions (A)	mm	2435	2435	2449	2449	2535
	inch	95.9	95.9	96.4	96.4	99.8
Dimensions (B)	mm	1048	1048	1175	1175	1810
	inch	41.3	41.3	46.3	46.3	71.3
Dimensions (C)	mm	1125	1125	1118	1118	1213
	inch	44.3	44.3	44.0	44.0	47.8
Weight	Kg	264	302	391	602	882
	Lbs	582	666	862	1327	1944

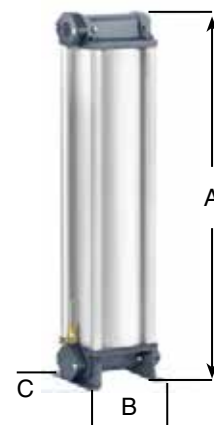

### Correction factors

For other compressed air inlet temperatures, please multiply the filter capacity by the following correction factor (Kt):

Inlet temperature	°C	20	25	30	35	40	45	50	55	60
	°F	68	77	86	95	104	113	122	131	140
Correction factor	Kt	1.67	1.43	1.25	1	0.71	0.56	0.37	0.25	0.19

For other compressed air inlet pressures, please multiply the filter capacity by the following correction factor (Kp):

Inlet pressure	barg	3	4	5	6	7	8	9	10	11	12	13
	psig	44	58	73	87	102	116	131	145	160	174	189
Correction factor	Kp	0.57	0.77	0.83	1	1	1	1	1.05	1.05	1.11	1.18

Correction factors for VT 11-15 (for other compressed air inlet temperatures)

Inlet pressure	°C	20	25	30	35	40	45	50	55	60	65
Correction factor	Kt	1	1	1	1	0,83	0,67	0,59	0,48	0,42	0,33

\* for oil free compressors correction factor is always 1



# H - High pressure filters

## Features & Benefits

- ▶ High reliability
  - High-performance aluminum or stainless steel housings to withstand ultimately high operational pressures
  - Double O-rings, epoxy sealed caps and anti-corrosive coated filter housing
- ▶ Maximum contaminant removal
  - Removal of dry and wet dust, particulates, oil aerosol and water droplets
  - High-efficiency glass fiber and fleece media
- ▶ Significant energy savings & limited system operating costs
  - Optimal design and filter media allow for low pressure drops
- ▶ Easy to service
  - Cartridge color based on type of filtration grade, makes it easy to service

## General Specifications

- ▶ Operating pressures: 50-100-350 barg / 725-1450-5075 psig
- ▶ Operating temperature range:
  - 0-120°C/32-248°F (for grades S, D, G & C)
  - 0-35°C/32-95°F (for grade V)
- ▶ Available grades:
  - G: general oil coalescing filtration (max oil carry-over: 0,08 mg/m<sup>3</sup>)
  - C: fine oil coalescing filtration (max oil carry-over: 0,007 mg/m<sup>3</sup>)
  - S: general dust filtration (99,92% at MPPS)
  - D: fine dust filtration (99,98% at MPPS)
  - V: oil vapor filtration (max oil carry-over: 0,003 mg/m<sup>3</sup>)
- ▶ Inlet and outlet connections: threaded
- ▶ Housing material: Aluminum (50 barg/725 psig only) or stainless steel (complete range)



## Applications



Laser cutting



PET bottling



Pressure testing of components

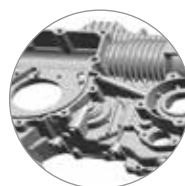

High-pressure die casting



Autoclave



Pneumatech's high pressure filters are engineered to cost effectively provide the best air purity and meet today's increasing quality demands up to working pressures of 350 barg/5075 psig. All high pressure filter housings are hydraulically tested to ensure safe and reliable operation at all times. The hydrostatic test certificate is supplied with every filter.

The high pressure filters are available in 3 pressure ranges. The 50 barg (725 psig) range is available in both aluminum and stainless steel housings. As the performance of both filters is the same, the choice between the 2 can be made based on the customer's preference. The 100 barg (1450 psig) and 350 barg (5075 psig) filters are available in stainless steel housings.

Technical specifications for HP 1-9 50 barg Aluminium Filters										
Pneumatech Variant→ Specifications ↓	Units	1	2	3	4	5	6	7	8	9
Capacity <sup>(1)</sup>	l/s	44	69	125	153	232	347	479	535	889
	m <sup>3</sup> /hr	160	250	450	550	835	1250	1725	1925	3200
	cfm	94	147	265	324	491	736	1015	1133	1883
Connection	BSP	¼"	3/8"	½"	¾"	1"	1½"	1½"	2"	2"
Dimensions (A)	mm	63	63	114	114	114	146	146	146	146
	inch	2.48	2.48	4.49	4.49	4.49	5.75	5.75	5.75	5.75
Dimensions (B)	mm	150	190	305	305	395	435	435	435	635
	inch	5.91	7.48	12.01	12.01	15.55	17.13	17.13	17.13	25.00
Weight	Kg	0.3	0.3	2.6	2.6	3.3	7.5	7.5	7.5	10
	Lbs	0.7	0.7	5.7	5.7	7.3	16.5	16.5	16.5	22.0

Technical specifications for HP 1-7 100 barg Stainless Steel								
Pneumatech Variant→ Specifications ↓	Units	1	2	3	4	5	6	7
Capacity <sup>(1)</sup>	l/s	28	88	128	189	333	472	944
	m <sup>3</sup> /hr	100	315	460	680	1200	1700	3400
	cfm	59	185	271	400	706	1001	2001
Connection	BSP	¼"	1/2"	¾"	1"	1"	1½"	2"
Dimensions (A)	mm	65	65	88	135	135	150	150
	inch	2.56	2.56	3.46	5.31	5.31	5.91	5.91
Dimensions (B)	mm	135	250	275	265	480	525	815
	inch	5.31	9.84	10.83	10.43	18.90	20.67	32.09
Weight	Kg	3.2	5.6	6.1	10.5	14.7	22	28
	Lbs	7.1	12.3	13.4	23.1	32.4	48.5	61.7

Technical specifications for HP 1-8 50 barg Stainless Steel									
Pneumatech Variant→ Specifications ↓	Units	1	2	3	4	5	6	7	8
Capacity <sup>(1)</sup>	l/s	28	56	94	139	278	472	567	944
	m <sup>3</sup> /hr	100	200	340	500	1000	1700	2040	3400
	cfm	59	118	200	294	589	1001	1201	2001
Connection	BSP	¼"	3/8"	½"	¾"	1"	1½"	2"	2"
Dimensions (A)	mm	85	85	85	110	110	150	150	150
	inch	3.35	3.35	3.35	4.33	4.33	5.91	5.91	5.91
Dimensions (B)	mm	202	227	257	270	422	517	517	817
	inch	7.95	8.94	10.12	10.63	16.61	20.35	20.35	32.17
Weight	Kg	1.7	2	2.2	4	5	15	15	21
	Lbs	3.7	4.4	4.9	8.8	11.0	33.1	33.1	46.3

Technical specifications for HP 1-6 350 barg Stainless Steel							
Pneumatech Variant→ Specifications ↓	Units	1	2	3	4	5	6
Capacity <sup>(1)</sup>	l/s	13	31	71	142	208	369
	m <sup>3</sup> /hr	48	111	255	510	750	1330
	cfm	28	65	150	300	441	783
Connection	BSP	¼"	¼"	½"	¾"	1"	1"
Dimensions (A)	mm	41	65	88.5	88.5	150	150
	inch	1.61	2.56	3.48	3.48	5.91	5.91
Dimensions (B)	mm	103	135	210	280	330	480
	inch	4.06	5.31	8.27	11.02	12.99	18.90
Weight	Kg	1.6	3.2	5.6	6.1	14.5	17.4
	Lbs	3.5	7.1	12.3	13.4	32.0	38.4

Correction factors: 50 barg Aluminum & Stainless Steel										
Operating pressure	barg	4	6	8	10	15	20	30	40	50
	psig	58	87	116	145	218	290	435	581	726
Correction factor	Kp	0.14	0.22	0.28	0.34	0.47	0.56	0.7	0.85	1

Correction factors: 100 barg Stainless Steel										
Operating pressure	barg	20	30	40	50	60	70	80	90	100
	psig	290	435	581	726	871	1016	1161	1306	1451
Correction factor	Kp	0.45	0.57	0.68	0.8	0.84	0.88	0.92	0.96	1

Correction factors: 350 barg Stainless Steel										
Operating pressure	barg	-	-	50	100	150	200	250	300	350
	psig	-	-	726	1451	2177	2903	3628	4354	5080
Correction factor	Kp	-	-	0.73	0.78	0.82	0.87	0.91	0.96	1



1. Flow is referred to an absolute pressure of 1 barg and temperature of 20°C

# SLF - Silicone free filters

## Features & Benefits

- ▶ Guaranteed silicone-free
  - Plasma-cleaned O-rings, diaphragms & gaskets
  - Metallic cylinders, housing components and fasteners washed at 80°C/176°F
  - Certificates delivered with SLF filters
- ▶ Maximum contaminant removal
  - Removal of dry and wet dust, particulates, oil aerosol and water droplets
  - High-efficiency glass fiber and fleece media
- ▶ Significant energy savings & limited system operating costs
  - Optimal design and filter media allow for low pressure drops
  - High reliability
  - High-performance stainless steel cores, double O-rings, epoxy sealed caps and anti-corrosive coated filter housing

## General Specifications

- ▶ Operating pressure range:  
2-16 barg / 29-232 psig
- ▶ Operating temperature range:
  - 0-66°C/32-151°F (for grades S, D, G & C)
  - 0-35°C/32-95°F (for grade V)
- ▶ Available grades:
  - G: general oil coalescing filtration (max oil carry-over: 0,1 mg/m<sup>3</sup>)
  - C: fine oil coalescing filtration (max oil carry-over: 0,01 mg/m<sup>3</sup>)
  - S: general dust filtration (99,81 % at MPPS)
  - D: fine dust filtration (99,97 % at MPPS)
  - V: oil vapor filtration (max oil carry-over: 0,003 mg/m<sup>3</sup>)
- ▶ Inlet and outlet connections: threaded



## Zooming in

### Avoid paint defects



Avoid blisters



Avoid poor adhesion



Avoid craters

The SLF filters are free from substances that could cause defects in the paint. The filters are manufactured in a controlled environment that ensures silicone is not present on the components used or introduced in the production process. All filters are subject to dimensional inspection, pressure &

performance testing and a paint compatibility test.

SLF filters are available in 5 grades, which efficiently prevent dry and wet dust, oil aerosol, oil vapor and water drops from entering your compressed air system.

Technical specifications for SLF Silicone-free filters												
Pneumatech Variant → Specifications ↓	Units	SLF 1	SLF 2	SLF 3	SLF 4	SLF 5	SLF 6	SLF 7	SLF 8	SLF 9	SLF 10	SLF 11
Nominal flow <sup>(1)</sup>	l/s	9	17	32	44	60	120	150	175	280	390	520
	m <sup>3</sup> /hr	32.4	61.2	115.2	158.4	216	432	540	630	1008	1404	1872
	cfm	19	36	68	93	127	254	318	371	594	827	1102
Connection	G/NPT	3/8"	1/2"	1/2"	3/4" & 1"	1"	1-1/2"	1-1/2"	1-1/2"	2" & 2-1/2"	3"	3"
Dimensions (A)	mm	90	90	90	110	110	140	140	140	179	210	210
	inch	3.54	3.54	3.54	4.33	4.33	5.51	5.51	5.51	7.05	8.27	8.27
Dimensions (B)	mm	61	61	61	98.5	98.5	105	105	105	121	128	128
	inch	2.40	2.40	2.40	3.88	3.88	4.13	4.13	4.13	4.76	5.04	5.04
Dimensions (C)	mm	268	268	323	374	414	520	603	603	689	791	961
	inch	10.55	10.55	12.72	14.72	16.30	20.47	23.74	23.74	27.13	31.14	37.83
Weight	Kg	1	1.1	1.3	1.9	2.1	4.2	4.5	4.6	6.9	11	12.6
	Lbs	2.2	2.4	2.9	4.2	4.6	9.3	9.9	10.1	15.2	24.3	27.8

1. Flow measured at reference conditions of Nominal pressure: 7 barg(e)/102 psig; temperature: 20°C, 68°F.

Correction Factors										
Inlet pressure	barg	2	4	6	7	8	10	12	14	16
Inlet pressure	psig	29	58	87	102	116	145	174	203	232
Correction factor		0.53	0.75	0.92	1	1.06	1.2	1.31	1.41	1.5



## FP & FP HP - Process filters (incl. high pressure)

### Features & Benefits

- ▶ Enhanced stainless steel (1,4301) filter housing
  - Designed for applications with high risk of corrosion
  - High hygiene standards
- ▶ Advanced filter cartridge design
  - High filtration efficiency
  - Guaranteed performance over the entire lifetime
  - Low pressure drop
- ▶ Ultimate strength
- ▶ 100% integrity tested (DOP test)
- ▶ All components meet the FDA requirements for contact with food in accordance with the Code of Federal Regulations (CFR), title 21.
- ▶ Wide range of cartridges to suit application needs

### General Specifications: FP 1-18

- ▶ Stainless steel process filters
- ▶ Operating pressure: 10-16 barg / 145-232 psig
- ▶ Operating temperature range<sup>1</sup>:  
0-150°C / 41-302°F
- ▶ Body connections: DIN 11851 (Milk pipe connections)
- ▶ Surface finish: Ra 1.6, electro-polished
- ▶ Inlet and outlet connections:  
Threaded and flanged.

<sup>1</sup>Operating temperature range can vary as per the filter element used.





In process industries where the risk of corrosion of the compressed air system components is high, Pneumatech's FP 1-18 process filter range provides the right solution. The filter housing is made out of stainless steel grade 1,4301. The surface has been smoothened with advanced mechanical and electro-polishing techniques to a level of Ra 1,6. To avoid

micro-organism contamination between the filter head and bowl, these are connected by a milk pipe connection as per DIN 11851.

The filter cartridges are available in 4 different filtration grades for a wide variety of applications. All cartridges have been extensively tested to guarantee the best filtration efficiency over the entire cartridge lifetime.

### Technical Specifications FP 1-18

Pneumatech Variant → Specifications ↓	Units	FP 1	FP 2	FP 3	FP 4	FP 5	FP 6	FP 7	FP 8	FP 9	FP 10	FP 11	FP 12	FP 13	FP 14	FP 15	FP 16	FP 17	FP 18
Flow <sup>1</sup>	m <sup>3</sup> /hr	75	105	150	225	315	420	600	900	1260	1680	2400	3600	5040	6720	9600	13440	17280	21120
	cfm	44	62	88	132	185	247	353	530	742	989	1413	2119	2966	3955	5650	7910	10171	12431
Operating Pressure	barg/psig	16/232	16/232	16/232	16/232	16/232	16/232	16/232	16/232	16/232	16/232	12/174	12/174	10/145	10/145	10/145	10/145	10/145	10/145
Connections	Inch	1/4"	3/8"	1/2"	3/4"	1"	1 1/4"	1 1/2"	2"	2"	2 1/2"	3"	3"	DN100	DN100	DN150	DN150	DN200	DN200
Dimensions	A (mm)	202	232	230	254	275	337	386	457	583	740	1004	1029	986	1240	1311	1351	1496	1496
	A (inch)	8.0	9.1	9.1	10.0	10.8	13.3	15.2	18.0	23.0	29.1	39.5	40.5	38.8	48.8	51.6	53.2	58.9	58.9
	B (mm)	116	120	125	125	136	155	180	180	180	224	224	252	410	410	480	540	660	660
	B (inch)	4.6	4.7	4.9	4.9	5.4	6.1	7.1	7.1	7.1	8.8	8.8	9.9	16.1	16.1	18.9	21.3	26.0	26.0
	C (mm)	76.1	76.1	76.1	76.1	88.9	88.9	114.3	114.3	114.3	139.7	139.7	168.3	219.1	219.1	273	323.9	406.4	406.4
	C (inch)	3.0	3.0	3.0	3.0	3.5	3.5	4.5	4.5	4.5	5.5	5.5	6.6	8.6	8.6	10.7	12.8	16.0	16.0
	D	1/4"	1/4"	1/4"	1/4"	1/4"	1/4"	1/4"	1/4"	1/4"	1/4"	1/4"	1/4"	1/4"	1"	1"	1"	1"	1"
Mass	Kg	1.7	1.9	1.9	2	2.6	3	4.3	4.8	5.3	9	10.8	16.2	45	46	70	80	135	135
	Lbs	3.7	4.2	4.2	4.4	5.7	6.6	9.5	10.6	11.7	19.8	23.8	35.7	99.2	101.4	154.3	176.4	297.6	297.6

1. Flow is measured at Reference Conditions: 1 bara and 20°C

### Technical specifications for FP HP 1-8

Pneumatech Variant → Specifications ↓	Units	FP HP 1	FP HP 2	FP HP 3	FP HP 4	FP HP 5	FP HP 6	FP HP 7	FP HP 8
Flow <sup>1</sup>	m <sup>3</sup> /hr	150	225	315	420	600	900	1260	2400
	cfm	88	132	185	247	353	530	742	1413
Operating Pressure	barg/psig	50/725	50/725	50/725	50/725	50/725	50/725	50/725	50/725
Connections	Inch	1/2"	3/4"	1"	1 1/4"	1 1/2"	2"	2"	3"
Dimensions	A (mm)	231	253	274	336	387	453	580	1005
	A (inch)	9.1	10.0	10.8	13.2	15.2	17.8	22.8	39.6
	B (mm)	125	125	136	155	180	180	180	224
	B (inch)	4.9	4.9	5.4	6.1	7.1	7.1	7.1	8.8
	C (mm)	76.1	76.1	88.9	88.9	114.3	114.3	114.3	139.7
	C (inch)	3.0	3.0	3.5	3.5	4.5	4.5	4.5	5.5
	D	1/4"	1/4"	1/4"	1/4"	1/4"	1/4"	1/4"	1/4"
Mass	kg	2.5	2.6	3.4	3.9	5.6	6.2	6.9	14.1
	Lbs	5.5	5.7	7.5	8.6	12.3	13.7	15.2	31.1

1. Flow is measured at Reference Conditions: 1 bara and 20°C

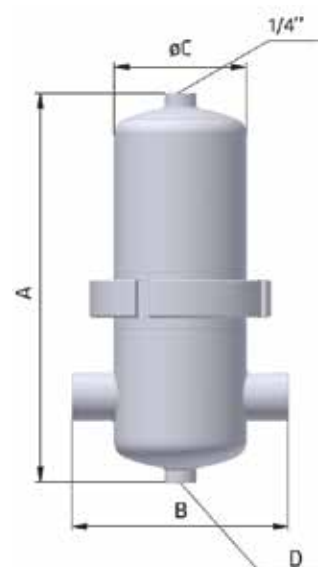

### Correction factors

Operating pressure	barg	2	3	4	5	6	7	8	9	10	11	12	13	14	15	16	20	30	40	50
	psig	29	44	58	72	87	100	115	130	145	160	174	189	203	218	232	100	290	435	725
Correction factor	Kp	0,38	0,5	0,63	0,75	0,88	1	1,13	1,25	1,38	1,50	1,63	1,75	1,88	2,00	2,13	2,63	3,88	5,13	6,38



## FS - Sterile filters

### Features & Benefits

- ▶ Enhanced high-grade stainless steel filter housing
  - Designed for applications with high risk of corrosion
  - High hygiene standards thanks to sanitary couplings
- ▶ Advanced filter cartridge design
  - High microbiological filtration efficiency
  - Designed to withstand a large number of sterilization cycles thanks to silicon bonded joint and additional NOMEX layer
- ▶ Stainless steel cylinders and end-caps
- ▶ Low pressure drop
- ▶ 100% integrity tested (DOP test)
- ▶ All components meet the FDA requirements for contact with food in accordance with the Code of Federal Regulations (CFR), title 21.

### General Specifications

- ▶ Operating pressure: -16 (12) barg/29-232 (174) psig
- ▶ Operating temperature range<sup>1</sup>: -20°C to 150°C/-4°F to 302°F
- ▶ Body connections: DIN 11851 (Milk pipe connections)
- ▶ Surface finish: Ra 0.8, electro-polished
- ▶ Inlet and outlet connections: threaded





Pneumatech's FSI filters are designed for compressed air and gas applications that need to be free from microbiological contamination, and can thus be sterilized regularly.

Pneumatech's FSI filter housings are made out of stainless steel grade 1.4404, with a surface that has been smoothed to a level of Ra 0,8. There is no void inside the entire filter housing; and thus no risk of micro-organism contamination.

The filter elements are manufactured with silicon as bonded joint to ensure robustness at high operating and sterilization

temperatures. For the same reason, an additional NOMEX layer is used at the inside and outside of the filter element. The filter cylinders and end-caps are made out of stainless steel. This all results in a highly efficient and exceptionally strong filter, which keeps its performance after a large number of sterilization cycles.

Filter Model	Pipe Size	Flow Rate		Dimension (mm)				Weight (kg) Approx.	Element Model
	G/NPT	Nm <sup>3</sup> /h	SCFM	A	B	C	D		
FSI 1	1/4"	75	44	225	116	76.1	1/8	1.7	-
FSI 2	3/8"	105	62	251	120	76.1	1/8	1.9	-
FSI 3	1/2"	150	88	253	125	76.1	1/8	1.9	-
FSI 4	3/4"	225	132	281	125	76.1	1/8	2.0	-
FSI 5	1"	315	185	290	136	88.9	1/8	2.6	-
FSI 6	1 1/4"	420	247	357	155	88.9	1/8	3.0	-
FSI 7	1 1/2"	600	353	408	179	114.3	1/4	4.3	-
FSI 8	2"	900	530	476	179	114.3	1/4	4.8	-
FSI 9	2"	1260	742	602	180	114.3	1/4	5.3	-
FSI 10	2 1/2"	1680	989	762	224	139.7	1/4	9.0	-
FSI 11	3"	2400	1413	1030	224	139.7	1/4	10.8	-
FSI 12	3"	3600	2119	1035	238	154	1/4	16.2	-

Correction factors																
Operating pressure	barg	2	3	4	5	6	7	8	9	10	11	12	13	14	15	16
	psig	29	44	58	72	87	100	115	130	145	160	174	189	203	218	232
Correction factor	Kp	0,38	0,50	0,63	0,75	0,88	1	1,13	1,25	1,38	1,50	1,63	1,75	1,88	2,00	2,13

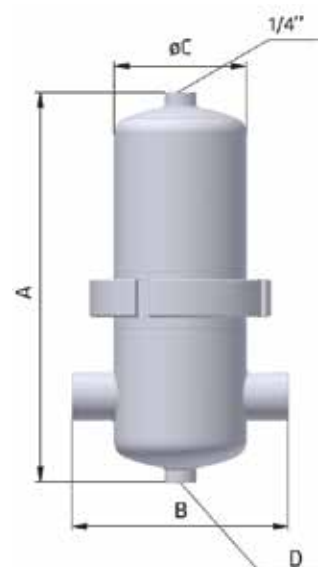

# TF DC - Filters with desiccant cartridges

## General Specifications

- ▶ Pressure dew point: -40°C
- ▶ Max working pressure: 16 barg/232 psig
- ▶ Operating temperature range: 1,5 – 45 °C/35 - 113 °F

The TF DC consists of a desiccant-filled cartridge, fit inside the standard Pneumatech filter housing. The desiccant dries the compressed air down to -40°C / -40°F but only has a limited lifetime, as it is not regenerated. The DC is therefore meant to dry small amounts of temporarily required compressed air; or as a safety filter downstream the main dryer.

The integrated dust filter collects any dust particles from the desiccant, making downstream dust filtration unnecessary. As with adsorption dryers, upstream oil coalescing filters are recommended to avoid that oily contaminants would stick to the desiccant.

### Technical specifications for Desiccant Cartridges

Filter Cartridge Size element → Specifications ↓	Unit	TF 2 DC	TF 4 DC	TF 5 DC	TF 6 DC
Nominal flow <sup>(1)</sup>	m <sup>3</sup> /hr	0,2	0,7	1	3,7
	cfm	0,12	0,41	0,59	2,18
Total Capacity <sup>(2)</sup>	m <sup>3</sup>	5	18	26	82
	Ft <sup>3</sup>	185,9	647,8	907,4	2898,5
Connections	inch	1/2"	3/4"	1"	1 1/2"
Molecular Sieves Mass	kg	0,056	0,196	0,278	0,878
	Lbs	0,12	0,43	0,61	1,94

1. Refers to 10s contact time at 7 barg operating pressure and 20°C.

2. Refers to 20°C inlet temperature, 100% relative humidity and 20% wt desiccant load capacity.



### Correction factor

Operating pressure	barg	2	3	4	5	6	7	8	9	10	11	12	13	14	15	16
	psig	29	44	58	73	87	102	116	131	145	160	174	189	203	218	232
Pressure correction factor	Kp	0.38	0.5	0.63	0.75	0.88	1	1.13	1.25	1.38	1.5	1.63	1.75	1.88	2	2.13

### Correction factor

Operating Temperature	°C	20	25	30	35	40	45
	°F	68	77	86	95	104	113
	Kt	1	0.98	0.97	0.95	0.94	0.92

# TF CC & TF HC - Filters with activated carbon & hopcalite cartridges

The cartridge-concept of the Desiccant Cartridges is also applied to activated carbon and hopcalite materials.

The activated carbon cartridge can be considered an intermediate solution between the carbon impregnated cartridge (V) and the activated carbon towers (VT). It provides thus a compact oil vapor filtration solution, albeit with a longer service life than the V filter.

Hopcalite is a catalyst which converts carbon monoxide into carbon dioxide. It is often used in breathing air applications to bring the carbon monoxide concentration below the prescribed thresholds of 15 ppm according to EN 12021 and 5 ppm according to the European Pharmacopeia.

Both solutions include an integrated dust filter. The correct filter sizing is usually based on the requested pressure drop over the filter.

## General Specifications

- ▶ Max working pressure: 16 barg / 232 psig
- ▶ Operating temperature range: 1,5 – 45 °C / 35 - 113 °F
- ▶ Service life: Dependent on inlet concentration – please consult Pneumatech for further support.



Technical specifications for Activated Carbon Cartridges

Filter grade→ Specifications↓	Unit	TF 2 CC	TF 4 CC	TF 5 CC	TF 6 CC
Flow Capacity <sup>(1)</sup>	m <sup>3</sup> /hr	72	144	216	396
	cfm	42	85	127	233
Connections	inch	1/2"	3/4"	1"	1 1/2"
Pressure Drop at Nominal Flow	mBar	80	110	120	420
	psig	1,16	1,60	1,74	6,09
Activated Carbon Mass	kg	0,04	0,14	0,199	0,627
	Lbs	0,1	0,3	0,4	1,4

1. Flow refers to 1 barg and 20°C at 7 barg operating pressure.

Technical specifications for Hopcalite Cartridges

Filter grade→ Specifications↓	Unit	TF 2 HC	TF 4 HC	TF 5 HC	TF 6 HC
Flow Capacity <sup>(1)</sup>	m <sup>3</sup> /hr	78	120	198	335
	cfm	46	71	117	197
Connections	inch	1/2"	3/4"	1"	1 1/2"
Pressure Drop at Nominal Flow	mBar	80	110	120	420
	psig	1,16	1,60	1,74	6,09
Hopcalite mass	kg	0,073	0,252	0,358	1,129
	Lbs	0,2	0,6	0,8	2,5

1. Flow refers to 1 barg and 20°C at 7 barg operating pressure.

### Correction factor

Operating pressure	barg	2	3	4	5	6	7	8	9	10	11	12	13	14	15	16
	psig	29	44	58	73	87	102	116	131	145	160	174	189	203	218	232
Pressure correction factor	Kp	0.38	0.5	0.63	0.75	0.88	1	1.13	1.25	1.38	1.5	1.63	1.75	1.88	2	2.13

# BA 15 - 310 - HE Breathing air purifiers

## Features & Benefits

- ▶ The Pneumatech solution for Industrial Breathing Air applications, build to exceed standards
- ▶ Compliance with stringent international standards
  - EN12021 & European Pharmacopeia
  - OSHA Grade D, NFPA-99, CSA Z180.1-00, CGA G7.1-1997,
  - BS 4275, ISO 14971, OHSAS 18001
- ▶ Special 7-stage filtration process offered unparalleled compressed air purity
  - Water Separator - For liquid water
  - Fine Filter - For Oil and Water aerosols
  - Super Fine Filter - For Oil and Water aerosols
  - Adsorption Dryer - For Water vapour and CO<sub>2</sub>
  - Activated Carbon - For Gaseous impurities
  - Catalyst - For CO oxidation to CO<sub>2</sub>
  - Bacteria Filter - For Bacteria & dust particles
- ▶ Advanced energy management for lowest operating costs
  - Compressor synchronization
  - Purge nozzle optimization
  - PDP control - Dew Point switching
- ▶ Advanced gas sensors
  - Direct reading from the controller screen
  - Voltage free contacts for easy integration
  - Adjustable level of warnings
- ▶ Best-in-class performance thanks to unique valve and exhaust design (patent pending)
  - Lowest pressure drop during drying
  - Lowest purge loss by ensuring maximum purge air expansion during regeneration
- ▶ Low noise levels
- ▶ High quality filters
  - Guaranteed air purity thanks to High-efficient glass fibre media.
  - Significant energy savings with lower pressure drops
- ▶ Compact and easy to connect design

## General Specifications

- ▶ Breathing Air Purifiers for Industrial applications.
- ▶ Dew points achievable: -40°C/-40°F
- ▶ Inlet pressure range: 4-14 barg/58-203 psig
- ▶ Ambient temperature range: 2-45°C/36-113°F
- ▶ Inlet temperature range: 2-50°C/36-122°F
- ▶ Power supply: 230 VAC 50 Hz/115 VAC 50Hz
- ▶ Maximum concentration of O<sub>2</sub> - 21,4%
- ▶ Reduced concentration of CO<sub>2</sub> below 700 PPM
- ▶ Reduced concentration of SO<sub>2</sub> /NO<sub>x</sub> below 5 PPM



## Options



Electronic drains



VT saturation indicator (Oil indicator)



O<sub>2</sub>, CO & CO<sub>2</sub> sensors



NPT connections



Optimised purge nozzle



The compressed air quality is of vital importance in many applications even more so in breathing air applications. The applications, such as short-blasting, tank cleaning, tunneling, spray painting and many more require breathing air that is free from contaminants that may be present in the compressed air fed breathing air systems. These contaminants are present in the feed air in the form of fumes, oil, vapors, gases, solid particles and microorganisms.

Pneumatech's breathing air purifiers offers guaranteed protection against such contaminants complying with International breathing Air standards. The BA HE range assures safe working environment in a wide range of applications. Built to exceed standards, BA HE purifiers provide certified breathing air, even

in situations with polluted intake air to ensure personnel safety at all times. The seven-filtration stages of the BA HE have been carefully designed to make sure the air quality at the outlet complies with EN12021 and European Pharmacopeia.

Specially engineered valve manifolds includes the pilot air controlled 3/2 valves with reliable and fast switching helps to reduce the pressure drop to a minimum. This does not only result in a low-pressure drop over the dryer, but also ensures maximum purge air expansion during regeneration. That lowers the purge air consumption drastically. The gas sensors are available as an option to optimize the system further. The possibility to connect the signals to the PureLogic Controller offers optimal control and monitoring.

Technical Specifications for BA 15 HE up to BA 310 HE										
Specifications ↓	Units	BA 15 HE	BA 30 HE	BA 55 HE	BA 75 HE	BA 105 HE	BA 150 HE	BA 170 HE	BA 210 HE	BA 310 HE
Nominal Volume flow at dryer 7 bar inlet	l/s	7	15	25	35	45	65	80	100	145
	m³/hr	25	54	90	126	162	234	288	360	522
Nominal Volume flow at dryer 10 bar inlet	l/s	8.4	18	30	42	54	78	96	120	174
	m³/hr	30	65	108	151	194	281	346	432	626
Nominal Volume flow at dryer 13 bar inlet	l/s	9.45	20.25	33.75	47.25	60.75	87.8	108	135	196
	m³/hr	34	73	122	170	219	316	389	486	706
Purge at 7 bar inlet	%	18	18	18	18	18	18	18	18	18
Purge at 10 bar inlet		15.4	15.4	15.4	15.4	15.4	15.4	15.4	15.4	15.4
Purge at 13 bar inlet		13.8	13.8	13.8	13.8	13.8	13.8	13.8	13.8	13.8
Pressure drop over breathing air dryer at max. flow	Bar	0.515	0.530	0.560	0.595	0.82	0.660	0.700	0.82	0.800
	PSI	7.5	7.7	8.1	8.6	11.9	9.6	10.2	11.9	11.6
Installed power	W	100	100	100	100	100	100	100	100	100
Height	mm	1580	1580	1580	1580	1580	1840	1840	1840	2019
	inch	62	62	62	62	62	72	72	72	79
Width	mm	650	650	650	650	650	850	850	850	850
	inch	26	26	26	26	26	33	33	33	33
Length	mm	1115	1115	1115	1115	1115	1115	1300	1300	1300
	inch	44	44	44	44	44	44	51	51	51
Net mass	Kg	169	172	172	174	188	252	273	333	388
	Lbs	373	379	379	384	414	556	602	734	855
Connection inlet/outlet	inch	1/2"	1/2"	1/2"	1"	1"	1"	1"	1 1/2"	1 1/2"

# BA 15 - 310 - S Breathing air purifiers

## Features & Benefits

- ▶ The Pneumatech solution for Industrial Breathing Air applications, build to exceed standards.
- ▶ Compliance with stringent international standards
  - EN12021 & European Pharmacopeia
  - OSHA Grade D, NFPA-99, CSA Z180.1-00, CGA G7.1-1997,
  - BS 4275, ISO 14971, OHSAS 18001
- ▶ Special 7-stage filtration process offered unparalleled compressed air purity
  - Water separator - For liquid water
  - Fine filter - For oil and water aerosols
  - Super fine filter - For oil and water aerosols
  - Adsorption dryer - For water vapour and CO<sub>2</sub>
  - Activated carbon - For gaseous impurities
  - Catalyst - For CO oxidation to CO<sub>2</sub>
  - Bacteria filter - For bacteria & dust particles
- ▶ Best-in-class performance thanks to unique valve and exhaust design (patent pending)
  - Lowest pressure drop during drying
  - Lowest purge loss by ensuring maximum purge air expansion during regeneration
- ▶ Low noise levels
- ▶ High quality filters
  - Guaranteed air purity thanks to High-efficient glass fiber media
  - Significant energy savings with lower pressure drops
- ▶ Compact and easy to connect design

## General Specifications

- ▶ Breathing air purifiers for industrial applications.
- ▶ Dew points achievable: -40°C/-40°F
- ▶ Inlet pressure range: 4-14 barg/58-203 psig
- ▶ Ambient temperature range: 2-45°C/36-113°F
- ▶ Inlet temperature range: 2-50°C/36-122°F
- ▶ Power supply: 230 VAC 50 Hz/115 VAC 50Hz
- ▶ Maximum concentration of O<sub>2</sub> - 21,4%
- ▶ Reduced concentration of CO<sub>2</sub> below 700 PPM
- ▶ Reduced concentration of SO<sub>2</sub> /NO<sub>x</sub> below 5 PPM



## Options



Electronic drains



VT saturation indicator (Oil indicator)



Gas sensors (As sales options)



NPT connections





The compressed air quality is of vital importance in many applications even more so in breathing air applications. The applications such as short-blasting, tank cleaning, tunneling, spray painting and many more require breathing air that is free from contaminants that may be present in the compressed air fed breathing air systems. These contaminants are present in the feed air in the form of fumes, oil, vapors, gases, solid particles and microorganisms.

Pneumatech's breathing air purifiers offers guaranteed protection against such contaminants complying with International breathing Air standards. The BA S range assures safe working environment in a wide range of applications. Built to exceed standards, BA S purifiers provide certified breathing air, even in situations with

polluted intake air to ensure personnel safety at all times. The seven-filtration stages of the BA S have been carefully designed to make sure the air quality at the outlet complies with EN12021 and European Pharmacopeia.

Specially engineered valve manifolds includes the pilot air controlled 3/2 valves with reliable and fast switching helps to reduce the pressure drop to a minimum. This does not only result in a low-pressure drop over the dryer, but also ensures maximum purge air expansion during regeneration. That lowers the purge air consumption drastically. Compact and easy to connect design make the BA S purifiers, a perfect solution for your breathing air needs.

#### Technical Specifications for BA 15 S up to BA 310 S

Specifications ↓	Units	BA 15 S	BA 30 S	BA 55 S	BA 75 S	BA 105 S	BA 150 S	BA 170 S	BA 210 S	BA 310 S
Nominal Volume flow at dryer 7 bar inlet	l/s	7	15	25	35	45	65	80	100	145
	m <sup>3</sup> /hr	25	54	90	126	162	234	288	360	522
Nominal Volume flow at dryer 10 bar inlet	l/s	8.4	18	30	42	54	78	96	120	174
	m <sup>3</sup> /hr	30	65	108	151	194	281	346	432	626
Nominal Volume flow at dryer 13 bar inlet	l/s	9.45	20.25	33.75	47.25	60.75	87.8	108	135	196
	m <sup>3</sup> /hr	34	73	122	170	219	316	389	486	706
Purge at 7 bar inlet	%	18	18	18	18	18	18	18	18	18
Purge at 10 bar inlet		15.4	15.4	15.4	15.4	15.4	15.4	15.4	15.4	15.4
Purge at 13 bar inlet		13.8	13.8	13.8	13.8	13.8	13.8	13.8	13.8	13.8
Pressure drop over breathing air dryer at max. flow	Bar	0.515	0.530	0.560	0.595	0.82	0.660	0.700	0.82	0.800
	PSI	7.5	7.7	8.1	8.6	11.9	9.6	10.2	11.9	11.6
Installed power	W	100	100	100	100	100	100	100	100	100
Height	mm	1580	1580	1580	1580	1580	1840	1840	1840	2019
	inch	62	62	62	62	62	72	72	72	79
Width	mm	650	650	650	650	650	850	850	850	850
	inch	26	26	26	26	26	33	33	33	33
Length	mm	1115	1115	1115	1115	1115	1115	1300	1300	1300
	inch	44	44	44	44	44	44	51	51	51
Net mass	Kg	169	172	172	174	188	252	273	333	388
	Lbs	373	379	379	384	414	556	602	734	855
Connection inlet/outlet	inch	1/2"	1/2"	1/2"	1"	1"	1"	1"	1 1/2"	1 1/2"

## Competitor spare parts - Alternative line filter cartridges

### Features & Benefits

- ▶ Guaranteed performance
  - Filter media selected to offer low differential pressure, high oil removal efficiencies and proven continuous performance
  - Performance equal to or superior than the original
- ▶ Robust design
  - Perforated support cylinders made from corrosion resistant stainless steel, which is twice as strong as galvanized steel
  - Protection layers to protect the glass fiber media from being damaged by the metal cores
- ▶ Guaranteed interchangeability
  - Designed to fit into the original housing
  - Tested in more than 10.000 filters in the field
- ▶ Quality control
  - Full traceability by ink jet marking specific codes on every filter element complying with our IOS 9001 manufacturing procedures



### Brands

Domnick Hunter	Dollinger (SPX)
Zander	Finite
Donaldson Ultrafilter	Kaeser
Hydrovane	CompAir
Hiross	Ingersoll Rand
Hankison (SPX)	Parker Balston
Deltech (SPX)	Sullair
CTA	FST
Bea Filtri	And many more



Pneumatech offers superior quality alternative line filters for all major brands including Domnick Hunter, Zander, Donaldson and many more. We can supply filtration solutions for any grade or class of air quality to suit all air compressor needs.

Pneumatech's high quality filter elements use the latest filter media technology and fit seamlessly into OEM machines

and housings. There is no need for modification kits or adapters. The elements offer unrivaled reliability and operate with minimal pressure drop, delivering optimum energy efficiency. All our brand alternatives are tested in accordance with ISO 12500 to guarantee exceptional performance. The filters are extensively tested in the field without any performance issues.

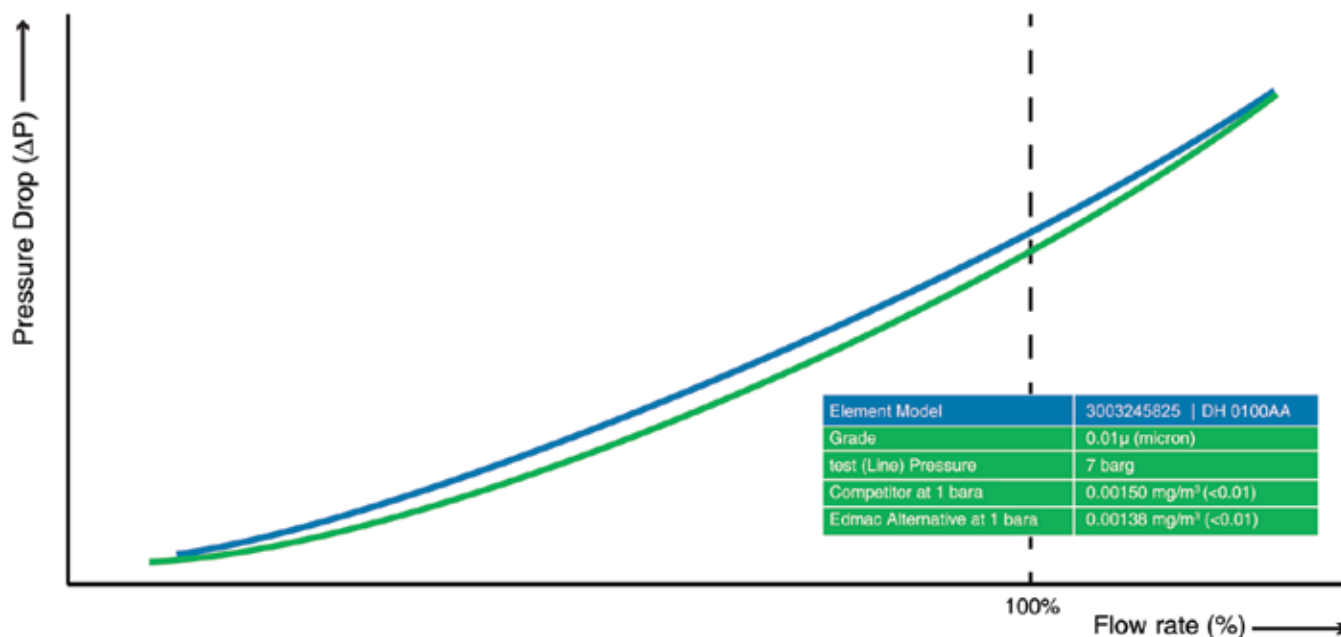
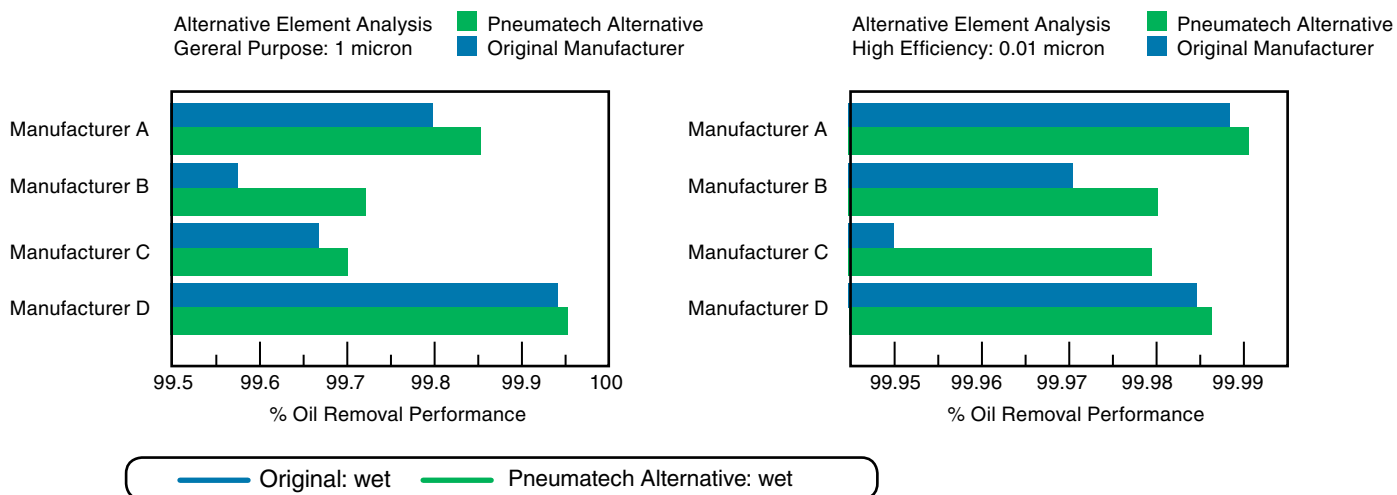

Grade	G		C		S		D		V	
Filter type	General oil coalescing		Fine oil coalescing		General dry dust		Fine dry dust		Oil vapor	
Maximum oil carryover (68°F / 20°C)	0.5 mg/m <sup>3</sup>		0.01 mg/m <sup>3</sup>		-		-		0.003 mg/m <sup>3</sup>	
Pressure loss clean and dry	1 psig	<70 mbar	2 psig	< 140 mbar	1 psig	< 70 mbar	2 psig	< 140 mbar	-	
Wet pressure drop	2 psig	< 140 mbar	3 psig	< 200 mbar	-	-	-	-	-	
Maximum temperature	248°F	120°C	248°F	120°C	248°F	120°C	248°F	120°C	122°F	50°C

## Competitor spare parts - Alternative desiccants

### Features & Benefits

- ▶ All types of desiccants, matched to the OEM performance
  - Activated alumina
  - Silicagel
  - Molecular sieves
  - Activated carbon
- ▶ High-quality supply at the lowest cost
  - Lowest total cost of ownership
  - Highest crushing resistance
  - Limited anti-aging effect

### Why choose Pneumatech for alternative spare parts?

- ▶ Excellent customer service
- ▶ Over 250.000 parts available
- ▶ Same day shipping
- ▶ World class logistics
- ▶ Full track and trace of all shipments
- ▶ Competitive pricing & flexible discounts
- ▶ Customized labelling

Adsorption dryers can only be energy efficient if they contain premium desiccant material. The desiccant used in Pneumatech adsorption dryers is carefully selected from a wide range of European and North-American suppliers; and is suitable for all OEM machines including Domnick Hunter, Donaldson, Boge, Ingersoll Rand, Compair, Kaeser, Almig and many more.



### Brands

Domnick Hunter	CompAir
Zander	Ingersoll Rand
Donaldson Ultrafilter	Boge
Hankison (SPX)	Almig
Deltech (SPX)	FST
CTA	KSI
Dollinger (SPX)	Parker Balston
Kaeser	And many more



## Protect the environment – treat your condensate

As efficient as the process may be, a compressor inevitably produces more than compressed air alone. One of its by-products is a large volume of condensate, generally an emulsified combination of oil and water that poses a serious environmental risk. Only by treating this condensate in the right way, we can make sure it brings no harm to the environment.

Depending on the location, severe penalties can be charged for dumping oily condensate in the sewage system. The legal threshold of the maximum oil concentration in water varies strongly depending on continent, country and even local region. However, the maximum allowable oil content in drainage to the sewage generally varies between 15 and 20 mg/l



# Condensate Management

Pneumatech's condensate management portfolio includes solutions for separating, draining, detecting and treating oily condensate.

Water separators can be used downstream of the compressor instead of - or together with - the air receiver. We offer three types of condensate drains depending on your needs: a timer drain, a mechanical zero loss float drain and an electronic zero loss drain. Also for condensate treatment we give you the choice, i.e. between the cost-competitive ECOBOX solution and our premium, patented OWS technology.

# WD - Water detector

## Features & Benefits

- ▶ 24/7 peace-of-mind at a reasonable cost
  - Water level as low as 3 cl detected
  - Can be installed at every critical application in the compressed air network
- ▶ Transparency of operation
  - Alarm message on control panel
  - Potential-free contact to trigger alarm in control room
  - Test button for manual drainage
- ▶ Easy mechanical and electrical installation

## General Specifications

- ▶ Water detector
- ▶ Operating pressure range:  
0,2-16 barg/2,9-232 psig
- ▶ Operating temperature range:  
1-60°C/34-140°F
- ▶ Power supply: 230VAC 50/60Hz



## Options



Power supply cable (2m)



Voltage-free contact cable (5m)



Despite all efforts to make dryers, water separators and drains reliable, a failure can never be ruled out. The consequence of condensate water in your pipe network and operations can be dramatic: from corrosion and ice formation to bad product quality and process malfunctioning.

The installation of a Pressure Dew Point (PDP) sensor downstream brings a solution, but is often a too large investment.

Pneumatech's Water Detector (WD) provides peace-of-mind at an affordable cost. The WD gives an alarm as soon as a 3cl water level is detected. This alarm message is visible, audible and can be routed to a control room thanks to the potential-free contact. The ball valve at the outlet is meant to release water after an alarm situation and is closed during normal operation.

Technical Specifications for WD	
General characteristics	WD
First alarm level (cl)	3
Second alarm level (cl)	6,7
Max. power consumption (W)	10
Electrical connection	Solenoid plug type B - 2+PE
Potential free contact connection	M12 connector A-coding 4-pole Both Normally Open (NO) and Normally Closed (NC) possible
IP Protection	IP65
Physical characteristics	WD
Length (mm / inch)	160 / 6,3
Width (mm / inch)	69 / 2,71
Height (mm / inch)	116 / 4,5
Weight (kg / Lbs)	0,6 / 1,32
Connections	WD
Inlet	G1/2", horizontal + vertical
Outlet	Ball valve for condensate removal
Features	WD
Test button	Yes
Indicative LEDs	Yes
Potential free alarm	Yes

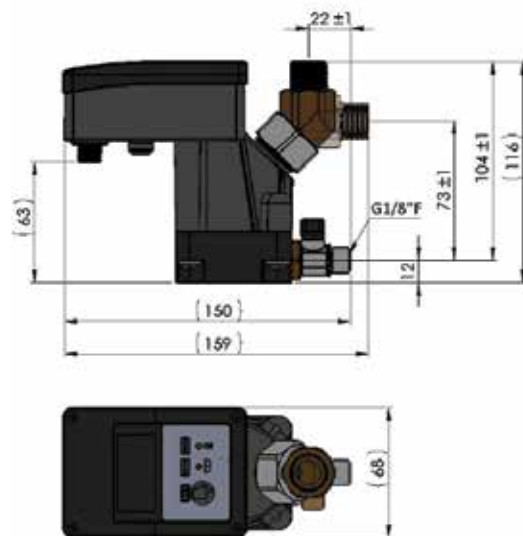

# LD 100 - 204 - Zero loss drains

## Features & Benefits

- ▶ No loss of compressed air
  - Automatic controlled drainage of condensate without any compressed air leak
- ▶ Maximum reliability
  - Integrated filter to prevent dirt from entering the valve diaphragm
  - Auto-repair algorithm: forced opening/closing cycles of the valve in case of malfunction
- ▶ Transparency of operation
  - Alarm message on control panel when drain is blocked
  - Potential-free contact to trigger alarm in control room
  - Test button for manual drainage
- ▶ Easy installation and maintenance
  - Straightforward mechanical and electrical connections
  - Wear kits available



## General Specifications

- ▶ Zero-loss drain
- ▶ Operating pressure range:  
0,2-16 barg/2,9-232 psig
- ▶ Operating temperature range:  
1-60°C/34-140°F
- ▶ Compressor capacity:  
from 180 up to 9500 m³/hr
- ▶ Power supply:  
230VAC 50/60Hz  
24VAC 50/60Hz  
115VAC 50/60Hz

## Options



Mounting kits



Wear kits



Power supply cable (2m)



Voltage-free contact cable (5m)



The series of LD zero-loss drains permit a controlled drainage of condensate without any compressed air leaks. All LD drains are equipped with an integrated storage tank, inside which a level sensor has been mounted. The sensor is controlled by an intelligent electronic circuit based on an 8-bit microprocessor logic. All drain functions are displayed on the control panel\*. A test push button is available on the control panel for manual drainage. A built-in filter prevents the solenoid valve from clogging.

In case of trouble, the control circuit unlocks the drain pipes by carrying out a series of forced opening/closing cycles of the

solenoid valve. If this is not enough, the malfunction is reported outside by an alarm with potential-free contact to draw the attention of maintenance staff\*.

The LD drains are produced in 10 different models with different flow rates. All versions are suitable for working with any type of condensate water.

\*not applicable for the smallest model LD100

#### Technical specifications for LD 100 - 204

Pneumatech Variant → Specifications ↓	LD100	LD101	LD 101 Compact	LD 101 L	LD200	LD200 L	LD202	LD202 L	LD203	LD204
<b>General characteristics</b>										
Drain capacity (l/h)	1.6	4.03	3.3	5	8.07	10	16.14	20	85	200
Compressor capacity (m <sup>3</sup> /hr) <sup>(1)</sup>	180	450	378	450	900	900	1800	1800	9500	18000
Compressor capacity (cfm) <sup>(1)</sup>	106	265	222	265	530	530	1059	1059	5591	10594
Max. power consumption (W)	10									
Electrical connection	Solenoid plug type B – 2+PE									
Potential free contact connection	/ M12 connector A-coding 4-pole									
IP Protection	IP65	IP65	IP65	IP65	IP 65	IP 65	IP 65	IP 65	IP 65	IP 65
<b>Physical characteristics</b>										
Length (mm)	136	163	160	163	163	163	163	163	188	247
Length (inch)	5.4	6.4	6.3	6.4	6.4	6.4	6.4	6.4	7.4	9.7
Width (mm)	60	69	69	69	69	69	69	69	130	130
Width (inch)	2.4	2.7	2.7	2.7	2.7	2.7	2.7	2.7	5.1	5.1
Height (mm)	120	140	120	140	155	155	214	214	230	230
Height (inch)	4.7	5.5	4.7	5.5	6.1	6.1	8.4	8.4	9.1	9.1
Weight (kg)	0.42	0.6	0.5	0.6	0.7	0.7	1.2	1.2	2.8	3.45
Weight (Lbs)	0.9	1.3	1.1	1.3	1.5	1.5	2.6	2.6	6.2	7.6
<b>Connections</b>										
Inlet	G1/2"	G1/2"	G1/2" (F)	G1/2" (F)	G1/2" (F)	2 x G1/2" (F)	G1/2" (F)	2 x G1/2" (F)	2 x G1/2" (F)	2 x G1/2" (F) + 1 x G3/4" (F)
Outlet	1 x Ø12	1 x Ø12	1 x Ø12	1 x Ø12	1 x Ø12	1 x Ø12	1 x Ø12	1 x Ø12	1 x Ø12	1 x Ø12
<b>Features</b>										
Test button	Yes									
Indicative LEDs	No	Yes								
Potential free alarm	No	Yes (NC/NO)								

1. The calculation of compressor capacity is based on the maximum condensate drainage of a compressor aftercooler in moderate climate conditions.

## TD - Timer drain

### Features & Benefits

- ▶ Guaranteed reliability
  - Robust solenoid, made in Europe
  - Integrated Y-filter to prevent dirt from entering the valve
  - Large cross-section openings
- ▶ Endless flexibility
  - No limitations in air flow
  - Cycle and valve opening intervals can be set independently of each other
- ▶ IP65 enclosed
- ▶ Transparency of operation
  - Test button and operation indicator

Pneumatech's TD condensate drains discharge the condensate automatically, based on pre-set time intervals. The opening and closing times can be set with high flexibility, which make the drains suitable for almost all capacities. TD drains are selected in heavy-duty operations, where the large cross-sections opening and the simplicity of the drain are highly valued.

High-pressure TD drains are available on request.



#### Technical specifications

Pressure range	0-16 barg/ 0-232 psig
Supply voltage	24VAC 50/60Hz & 230VAC 50/60Hz (CE)
Electrical connection	DIN43650A
Inlet/outlet connections	G 1/2" (CE) NPT 1/2" (UL)
Environmental protection	IP65
Max. compressor capacity	No limit
Min/Max operating temperature	1-50°C/ 34-122°F
Timer cycle	On: 0,5 – 10 s; Off: 0,5 – 45 min. including test feature
Valve type	2/2 direct acting
Valve orifice	4.5 mm- 0,177"
Valve seal	FKM

## MD - Mechanical zero-loss float drain

Pneumatech's MD drain discharges the condensate automatically and without compressed air losses up to 16 barg. A floating body rises and falls with the condensate level in a collecting chamber; and opens/closes a mechanical drain valve. The condensate collecting chamber is closed off from the compressed air flow when the drain is depressurized.

The drain is equipped with an integrated venting function, which prevents the risks of possible air slots. The MD has a well-proven, rugged metal design with threaded connections at inlet and outlet.



### Features & Benefits

- ▶ No loss of compressed air
  - Automatic controlled drainage of condensate without any compressed air leak
- ▶ Plug-and-play solution
  - No power supply needed
  - No programming or calibration
- ▶ Guaranteed reliability
  - Large cross-section openings
  - Well-proven, rugged aluminum design
  - Integrated venting function to prevent air slots
- ▶ Transparency of operation
  - Manual drain valve for system discharge and operational check

#### Technical specifications

Pressure range	0-16 barg / 0-232 psig
Inlet/outlet connections	G ½" (CE)
Max. water discharge capacity	250 l/h @ 7 barg / 0,147 cfm @ 101 psig 360 l/h @ 16 barg / 0,212 cfm @ 232 psig
Max compressor capacity (without dryer)	5.400 m <sup>3</sup> /hr / 3178 cfm
Length	156 mm / 6,14"
Width	108 mm / 4,25"
Height	111 mm / 4,37"
Weight	0,9 kg / 2 lbs

# ECOBIX 1 - Small oil water separator

## Features & Benefits

- ▶ Excellent performance
  - 2-stage filtration with advanced adsorption media
  - After separation, water contains oil levels below 15 ppm<sup>(1)</sup>
- ▶ Environmentally friendly - all materials are 100% recyclable
- ▶ Compact footprint - compact and lightweight design, optimized for small compressor installations
- ▶ Quick and easy installation and replacement – by means of a wall or plate mounting bracket
  - Optional sampling kit to verify outlet concentration on a regular base
- ▶ DIBT certified



## Options



Sampling kit



The Pneumatech ECOBOX offers a compressor condensate cleaning solution with excellent performance for compressed air systems up to 100 m<sup>3</sup>/hr (60 cfm). It is designed to remove the oil traces from compressor condensate via 2-stage adsorption. The ECOBOX is able to clean the compressor condensate to

oil concentrations below 15 ppm<sup>1</sup> by using a new, advanced filter medium. General country legislations for oil in water contamination are 20 ppm<sup>1</sup>. It is specifically designed to offer an affordable condensate cleaning solution for piston compressor and small screw compressor installations.

Technical specifications for ECOBOX			
Capacity	15 l/s - 51 m <sup>3</sup> /hr - 30 cfm	25 l/s - 85 m <sup>3</sup> /hr - 50 cfm	30 l/s - 100m <sup>3</sup> /hr - 60 cfm
Oil Residual	15 ppm	15 ppm	15 ppm
Expected Life Time - Cold Climate <sup>(2)(3)</sup>	6000	4000	3000
Expected Life Time - Normal Climate <sup>(2)(3)</sup>	6000	4000	-
Expected Life Time - Hot Climate <sup>(2)(3)</sup>	4000	-	-
Suitable compressor	Piston Compressor 2-7,5 hp	Screw Compressor 3-10 hp	Screw Compressor 15 hp

Type	Rated Flow <sup>(2)</sup>				Connections				Weight		Dimensions					
	l/s	m <sup>3</sup> /hr	l/min	cfm	Inlet	Outlet	kg	lbs	mm			inch				
									A	B	C	A	B	C		
ECOBOX	<30	<100	<1800	<60	6 mm	1/4"	10 mm	3/8"	1	2.2	240	140	140	9.5	5.5	5.5

- 15ppm is generally well below the acceptance level for disposal in the sewage, but due to strongly varying international and local regulations, it is the user's responsibility to consult local waste water discharge regulations and ensure compliance.
- In tropical climates (high ambient temperatures and humidity levels), the air generally contains more water vapor. The extra condensate, generated during the compression and cooling process of the air, shortens the contact time in the device, leaving less time for the media to absorb the oil. Climatic conditions used in the table above are defines as follows:
  - Cold climate conditions: average ambient temperature of 20°C/ 68°F- relative humidity of 50 %
  - Normal climate conditions: average ambient temperature of 25°C/ 75°F - relative humidity of 60%
  - Hot climate conditions: average ambient temperature of 35°/ 95°F - relative humidity of 70 %
- Pneumatech assumes as well maintained compressor plant and reasonable operating conditions. Performance on mineral or mineral-based lubricants should be as above, irrespective of compressor type, condensate drain technology or climate,provided the condensate produced is not a stable emulsion.





## ECOBIX 2 - 4 - Oil water separators

### Features & Benefits

- ▶ Excellent performance
  - 2-stage filtration with advanced adsorption media
  - After separation, water contains oil levels below 15 ppm<sup>(1)</sup>
  - Emulsion treatment possible (on request)
- ▶ Eliminating potential health issues
  - No standing or stagnant water
- ▶ Plug-and-play installation and service
  - Connection points at inlet
  - Compact footprint
  - No pre-soaking required
- ▶ Time-based service indicator and sampling kit (standard) to verify outlet concentration on a regular base.



### Options



Extra 4 port kit



Pneumatech extends its cost-competitive ECOBOX condensate cleaning solution with 3 more models, up to 1400 m<sup>3</sup>/hr. The models are designed according to the same success factors: reliable double adsorption with recycled glass media, compact footprint, and easy installation and service.

Additionally the ECOBOX 2 - 4 has 4 connections points at the inlet; and a sample test point at the outlet.

Technical specifications for ECOBOX 2-4				
		ECOBOX 2	ECOBOX 3	ECOBOX 4
Maximum rated flow - normal climate <sup>(2)</sup>	l/s	53	158	389
	m <sup>3</sup> /hr	190	570	1400
	cfm	112	335	824
Connections	Inlet	4x 12mm	4x 12mm	4x 12mm
		4x 1/2"	4x 1/2"	4x 1/2"
	Outlet	12mm	20mm	20mm
		1/2"	3/4"	3/4"
Weight	kg	2,7	3,6	14,8
	lbs	6,0	7,9	32,6
Dimensions	Length (mm)	215	345	432
	Length (inch)	8,46	13,58	17,01
	Width (mm)	257	282	495
	Width (inch)	10,12	11,10	19,49
	Height (mm)	500	654	989
	Height (inch)	19,69	25,75	38,94
Service life for filter <sup>(3)</sup>		4,000 Operating Hrs	4,000 Operating Hrs	4,000 Operating Hrs

- 15ppm is generally well below the acceptance level for disposal in the sewage, but due to strongly varying international and local regulations, it is the user's responsibility to consult local waste water discharge regulations and ensure compliance.
- In tropical climates (high ambient temperatures and humidity levels), the air generally contains more water vapor. The extra condensate, generated during the compression and cooling process of the air, shortens the contact time in the device, leaving less time for the media to absorb the oil. Climatic conditions used in the table above are defines as follows:
  - Cold climate conditions: average ambient temperature of 20°C/ 68°F- relative humidity of 50 %
  - Normal climate conditions: average ambient temperature of 25°C/ 75°F - relative humidity of 50%
  - Hot climate conditions: average ambient temperature of 35°/ 95°F - relative humidity of 70 %
- Pneumatech assumes as well maintained compressor plant and reasonable operating conditions. Performance on mineral or mineral-based lubricants should be as above, irrespective of compressor type, condensate drain technology or climate, provided the condensate produced is not a stable emulsion.

# OWS 75 - 5000 - Oil water separators

## Features & Benefits

- ▶ Stable and reliable performance thanks to patented multistage filtration technology
  - Filtering all types of condensate & most condensate emulsions
  - No use of rotating equipment
  - No risk of spillage thanks to large capacity chamber design
- ▶ Eliminating all potential health issues
  - No standing or stagnant water
  - Optional anti-bacteria kit
- ▶ Accurate and quick indication of filter replacement thanks to maintenance indicator, blockage indicator and sampling kit
- ▶ DIBT certified
- ▶ Hassle-free maintenance with genuine service kits

## General Specifications

- ▶ Oil water separator
- ▶ Designed outlet oil content : 15 mg/l
- ▶ Flow range at mild ambient conditions: 127-8500 m<sup>3</sup>/hr/75-5003 cfm



## Options



Low temperature kit



Photo electric sensor & switch



Multiple inlet manifold



Anti-bacteria kit



Pneumatech offers a patented way to turn oily condensate into harmless water that can be drained away, while capturing the oil to be easily disposed of in an environmentally friendly manner. The multi-stage separation process, using both buoyant oleophilic filters and activated carbon ensures exceptional performance, lower disposal costs and trouble free operation.

The OWS range eliminates oil through multi-stage filtration rather than the conventional gravity systems which have limitations on the type of condensate that can be treated. As a result, the OWS separator capacity is not linked to the type of emulsion collected since it can treat the same volume of condensate whether saturated with mineral oil, semi-synthetic oil or polyglycol.

Technical specifications for OWS 75 – OWS 5000										
Installation Type	Pneumatech Variant → Specifications ↓	Units	OWS 75	OWS 200	OWS 300	OWS 750 <sup>7</sup>	OWS 1280 <sup>7</sup>	OWS 1750 <sup>7</sup>	OWS 2500 <sup>7</sup>	OWS 5000 <sup>7</sup>
Complete installation <sup>(1)</sup> With Dryer <sup>(2)</sup>	Cold Climate <sup>3</sup>	m <sup>3</sup> /hr <sup>(6)</sup>	234	649	972	2396	4142	5583	7996	15993
		cfm <sup>(6)</sup>	138	382	572	1410	2438	3286	4706	9413
	Mild Climate <sup>4</sup>	m <sup>3</sup> /hr <sup>(6)</sup>	127	342	522	1279	2180	2972	4251	8500
		cfm <sup>6</sup>	75	201	307	753	1283	1749	2502	5003
	Hot Climate <sup>5</sup>	m <sup>3</sup> /hr <sup>(6)</sup>	61	161	251	612	1045	1441	2052	4123
		cfm <sup>(6)</sup>	36	95	148	360	615	848	1208	2427
Complete installation <sup>(1)</sup> Without Dryer <sup>(2)</sup>	Cold Climate <sup>3</sup>	m <sup>3</sup> /hr <sup>(6)</sup>	379	1009	1495	3728	6483	8682	12428	24840
		cfm <sup>(6)</sup>	223	594	880	2194	3816	5110	7315	14620
	Mild Climate <sup>4</sup>	m <sup>3</sup> /hr <sup>(6)</sup>	161	425	630	1566	2737	3673	5241	10483
		cfm <sup>(6)</sup>	95	250	371	922	1611	2162	3085	6170
	Hot Climate <sup>5</sup>	m <sup>3</sup> /hr <sup>(6)</sup>	71	178	272	685	1189	1585	2270	4538
		cfm <sup>(6)</sup>	42	105	160	408	700	933	1336	2671
Connections	inlet (BSP/NPT)		1x1/2"	2x1/2"	2x1/2"	2x3/4"	2x3/4"	2x3/4"	2x3/4"	2x3/4"
	outlet (BSP/NPT)		1x1/2"	1x1/2"	1x1/2"	1x3/4"	1x3/4"	1x3/4"	1x3/4"	1x1"
Dimensions	Length	mm	470	680	680	750	750	945	945	945
		inch	18,5	27	27	30	30	37	37	37
	Width	mm	165	255	255	546	546	650	695	1185
		inch	6,5	10	10	21,5	21,5	26	27	47
	Height	mm	610	762	762	889	1041	1092	1092	1092
		inch	24	30	30	35	41	43	43	43
	Weight	kgs	4	13	15	25	26	28	30	60
		lbs	9	29	33	55	57	62	66	132

1. Complete installation includes filters & air receiver.
2. All capacities are based on outlet oil content of 15 ppm and 12h operation. Derating needs to be proportionally applied.
3. Cold climate refers to ambient temperature of 15°C/ 59°F and relative humidity of 60%.
4. Mild climate refers to ambient temperature of 25°C/ 77°F and relative humidity of 60%.
5. Hot climate refers to ambient temperature of 35°C/ 95°F and relative humidity of 70%.
6. For poly-glycol based condensates, the capacity of each unit should be halved.
7. OWS -750 and larger are 3 tower units.

**Note:** Capacity is based on the compressor running at 7 barg / 100 psig for 12 hours per day, with all condensate from the compressor, the air receiver, the filters and fridge dryer being piped into the unit.

## CA - Air cooled aftercoolers

### Features & Benefits

- ▶ Highly efficient axial fans
- ▶ Cooling down to 10°C/18°F above ambient
- ▶ Negligible pressure drop
- ▶ Robust construction and compact design
- ▶ Easy to dismantle for cleaning

### General Specifications

- ▶ Air cooled aftercooler
- ▶ Max. operating pressure: 15 barg/218 psig
- ▶ Operating temperature: 170°C/338°F
- ▶ Approach above ambient temperature: 10°C/18°F
- ▶ Flow Rate: 66 to 4500 Nm<sup>3</sup>/hr (39 to 2649 cfm)



Compressed air will always be 100% saturated with water when it leaves a compressor. But also the outlet temperature has an important influence on the water load downstream the compressor. In order to minimize the load – and thus size – of the downstream refrigeration or adsorption dryer, it is therefore recommended to install a highly efficient aftercooler between the compressor and the dryer.

Pneumatech's air cooled aftercoolers CA 1-14 consist of a reliable axial fan with supreme efficiency. The fan forces ambient air over the copper tubes and aluminum fins of the heat exchanger. Hence the compressed air is cooled down to only 10°C/18°F above ambient temperature.

In this way, the CA is a simple product, but with a major impact on the investment and lifecycle cost of your downstream equipment!

#### Technical specifications for air cooled aftercoolers CA 1-14

Pneumatech Variant → Specifications ↓	Units	CA 1	CA 2	CA 3	CA 4	CA 5	CA 6	CA 7	CA 8	CA 9	CA 10	CA 11	CA 12	CA 13	CA 14
Flow <sup>(1)</sup>	m <sup>3</sup> /hr	66	126	222	294	390	522	774	990	1260	1560	1890	2520	3090	4500
	scfm	39	74	131	173	230	307	456	583	742	918	1112	1483	1819	2649
PipeSize	inch	G1"	G1"	G1 1/2"	G1 1/2"	G2"	G2"	G2"	G2 1/2"	DN100	DN100	DN100	DN100	DN125	DN125
Power Supply	Ph/Volt/Fr	1/230/50	1/230/50	3/400/50	3/400/50	3/400/50	3/400/50	3/400/50	3/400/50	3/400/50	3/400/50	3/400/50	3/400/50	3/400/50	3/400/50
Fan	Ø mm -W	Ø250-45W	Ø250-45W	Ø350-110W	Ø400-130W	Ø500-540W	Ø500-540W	Ø630-370W	Ø630-370W	Ø800-1470W	Ø800-1470W	Ø800-1470W	Ø800-1470W	2xØ800-1470W	2xØ800-1470W
Dimensions	A (mm)	957	957	1024	1024	1136	1136	1450	1450	1634	1634	1800	2000	2090	2300
	A (inch)	37.7	37.7	40.3	40.3	44.7	44.7	57.1	57.1	64.3	64.3	70.9	78.7	82.3	90.6
	B (mm)	320	320	368	368	355	355	465.5	465.5	564.1	564.1	790	795	830	850
	B (inch)	12.6	12.6	14.5	14.5	14.0	14.0	18.3	18.3	22.2	22.2	31.1	31.3	32.7	33.5
	C (mm)	400	400	490	490	764	764	775	775	1616	1616	1560	1740	1850	2010
	C (inch)	15.7	15.7	19.3	19.3	30.1	30.1	30.5	30.5	63.6	63.6	61.4	68.5	72.8	79.1
Weight	kg	19	20	27	29	44	48	61	66	127	143	148	166	212	315
	lbs	41.9	44.1	59.5	63.9	97.0	105.8	134.5	145.5	280.0	315.3	326.3	366.0	467.4	694.5

1. Flow refers to 1 barg and 20°C at 7 barg operating pressure.

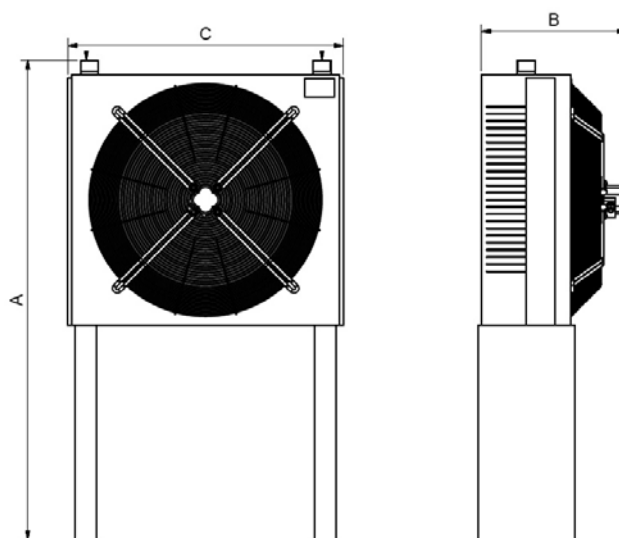

Note : In- and outlet connections can be chosen freely in the 4 corners of the heat exchanger

## CW 1 - 17 - Water cooled aftercoolers

### Features & Benefits

- ▶ Close temperature approach thanks to counter-current heat exchange
- ▶ Robust shell-and-tube design: stainless steel tubes within coated shell
- ▶ Negligible pressure drop
- ▶ Compact design
- ▶ Detailed calculations available on request

### General Specifications

- ▶ Water cooled aftercooler
- ▶ Operating pressure of compressed air: 0-16 barg/0-232 psig
- ▶ Operating temperature of compressed air: 2-200°C/35-392°F
- ▶ Flow Rate: 132 to 45570 Nm<sup>3</sup>/hr/  
78 to 26821 cfm





Compressed air will always be 100% saturated with water when it leaves a compressor. But also the outlet temperature has an important influence on the water load downstream the compressor. In order to minimize the load – and thus size – of the downstream refrigeration or adsorption dryer, it is therefore recommended to install a highly efficient aftercooler between the compressor and the dryer.

Pneumatech's water cooled aftercoolers CW 1-17 are robust shell-and-tube heat exchangers with excellent efficiency. Hot compressed air or gas passes through the stainless steel tubes while cooling water flows in counter-current around the tubes. This results in a minimal temperature difference between the outgoing compressed air and the incoming cooling water. Detailed design calculations are available on request.

Technical specifications for CW 1-17																		
Pneumatech Variant → Specifications ↓	Units	CW 1	CW 2	CW 3	CW 4	CW 5	CW 6	CW 7	CW 8	CW 9	CW 10	CW 11	CW 12	CW 13	CW 14	CW 15	CW 16	CW 17
Flow <sup>(1)</sup>	m <sup>3</sup> /hr	132	235	367	661	955	1323	2205	3087	3969	7056	8967	11025	16170	22050	26460	33810	45570
	cfm	78	138	216	389	562	779	1298	1817	2336	4153	5278	6489	9517	12978	15574	19900	26821
Connections Air side	inch	DN 50	DN 50	DN 50	DN 50	DN 50	DN 80	DN 80	DN 125	DN 125	DN 200	DN 200	DN 250	DN 300	DN 400	DN 400	DN 450	DN 500
Connections Water side	inch	DN 20	DN 20	DN 20	DN 20	DN 20	DN 20	DN 20	DN 32	DN 32	DN 50	DN 65	DN 80	DN 80	DN 100	DN 150	DN 200	DN 200
Operating Pressure	barg	0-16	0-16	0-16	0-16	0-16	0-16	0-16	0-16	0-16	0-16	0-16	0-10	0-10	0-10	0-10	0-10	0-10
	psig	0-232	0-232	0-232	0-232	0-232	0-232	0-232	0-232	0-232	0-232	0-232	0-232	0-232	0-232	0-232	0-232	0-232
Dimensions	A (mm)	806	816	816	870	870	1500	1510	1300	1300	1300	1300	1300	1300	1300	1300	1300	1300
	A (inch)	31.7	32.1	32.1	34.3	34.3	59.1	59.4	51.2	51.2	51.2	51.2	51.2	51.2	51.2	51.2	51.2	51.2
	B (mm)	60.3	60.3	60.3	60.3	60.3	88.9	88.9	139.7	139.7	219	219	273	323.9	406	406	457	508
	B (inch)	2.4	2.4	2.4	2.4	2.4	3.5	3.5	5.5	5.5	8.6	8.6	10.7	12.8	16.0	16.0	18.0	20.0

1. Refers to 1 barg and 20°C at 7 barg operating pressure and inlet temperature of 120°C.

Please consult Pneumatech team for accurate sizing based on the operating conditions. Given table is only valid at the reference conditions hence the sizing has to be validated to confirm the performance of the selected version.

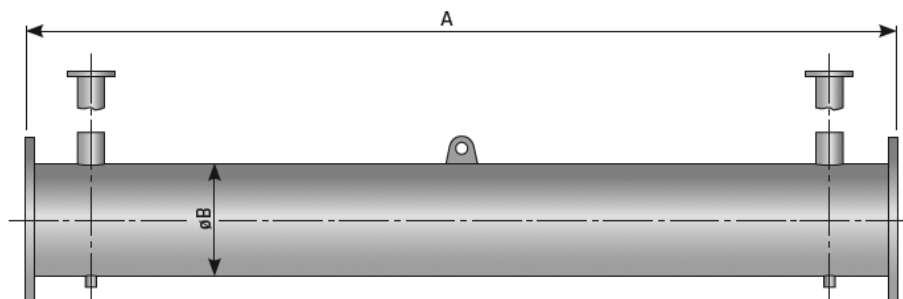

## **The importance of defining the right purity**

Purity has a substantial impact on the sizing and the energy efficiency of a gas generator. In order to increase purity, air needs to stay longer in contact with the adsorbent, meaning that the outlet flow needs to be reduced substantially.

It is thus very important to define the right purity for the right application. High purity levels are often recommended by gas companies to make the business case for on-site gas generators look worse and to defend their own business. There are however few applications requiring purity levels above 99,9% nitrogen purity.



# Gas Generators

Pneumatech designs and manufactures both standard and engineered on-site gas generator products. Nitrogen and oxygen generators are available with Pressure Swing Adsorption (PSA) technology, resulting in nitrogen purities up to 99,999% and oxygen purities up to 95%. Membrane technology is also offered for nitrogen purity levels up to 99,5%.

Pre-defined high-pressure nitrogen skids have been developed as a plug-and-play solution for various applications like laser-cutting. Our engineering department hence becomes your best partner for all kinds of special requests.

# PPNG 6 - 68 HE - Nitrogen generator with pressure swing adsorption technology

## Features & Benefits

- ▶ Advanced energy saving control
  - Reduced air consumption at low nitrogen demand
  - Also compensates for altering ambient conditions and purity settings
  - No compressed air use when no nitrogen is consumed
- ▶ Outstanding air factors thanks to back-flow pressurization
- ▶ High-quality, high-efficient Carbon Molecular Sieves selected for the right application
- ▶ Guaranteed purity
  - Automatically regulates to the requested nitrogen pressure and purity
  - Zirconia sensors for reliable purity measurement
- ▶ Designed & tested for cyclic load
- ▶ Optimal control and monitoring thanks to Purelogic™ Controller
  - Self-protective monitoring of the feed air quality
  - Feed-air blow-off in case of contamination
  - Nitrogen flow, purity and pressure measured and controlled
  - Automatic start-up

## General Specifications

- ▶ Pressure Swing Adsorption (PSA) nitrogen generators - extruded profile design
- ▶ Nitrogen purity achievable: 95% - 99.9% (PCT Variant) & 99.95%-99.999% (PPM variant)
- ▶ Inlet pressure range: 4-13 barg /60-189 psig
- ▶ Inlet temperature range: 5-60°C/41-140°F
- ▶ Required inlet air quality: 1-4-1 according to ISO 8573-1:2010
- ▶ Power supply: 115-230VAC/50-60Hz



## Options



Wooden packaging



The PPNG6-68HE series is Pneumatech's premium on-site nitrogen solution for low to medium flows, with best-in-class performance and the most complete scope of supply.

The generator has outstanding air factors at full load thanks to the use of highly efficient Carbon Molecular Sieves (CMS) and back-flow pressurization.

The air consumption is also optimized at reduced nitrogen flow or pressure demands, thanks to the advanced energy

saving algorithm, which automatically adjusts the cycle times of the generator.

The control and monitoring capabilities of the PPNG6-68 HE are truly impressive. Purity is guaranteed at all times by opening the consumer valve only at the requested purity level and flushing nitrogen when purity is not reached. Feed air quality is controlled by monitoring temperature, pressure and PDP. The feed air is blown off in case of contamination. All risks of possible CMS damage are eliminated thanks to the automatic start-up feature.

Technical specifications for PPNG 6 - PPNG 68 HE																	
Specifications	Units	Variant	Product → Purity ↓	PPNG 6 HE	PPNG 7 HE	PPNG 9 HE	PPNG 12 HE	PPNG 15 HE	PPNG 18 HE	PPNG 22 HE	PPNG 28 HE	PPNG 30 HE	PPNG 37 HE	PPNG 41 HE	PPNG 50 HE	PPNG 63 HE	PPNG 68 HE
Nominal free nitrogen delivery <sup>(1)</sup>	m <sup>3</sup> /hr	PCT (%)	95	18.4	23.4	28.8	36.4	46.8	57.2	70.2	86.0	93.6	114.8	128.9	157.7	NA	NA
			99.9	5.8	7.2	9.0	11.5	14.8	18.0	22.0	26.6	29.2	35.6	40.7	49.7	61.9	66.6
		PPM (%)	99.999	1.9	2.5	2.9	4.0	5.0	6.1	7.9	9.7	10.4	13.0	15.8	19.4	22.7	25.9
Nominal air consumption	m <sup>3</sup> /hr	PCT (%)	95	33.8	43.6	53.3	67.7	87.1	106.6	130.7	159.8	174.2	213.1	243.7	298.1	NA	NA
			99.9	18.0	23.4	28.4	36.4	46.8	56.9	69.8	85.7	93.2	114.1	135.7	166.0	196.9	221.0
		PPM (%)	99.999	12.2	15.5	19.1	24.1	31.3	38.2	44.3	54.0	59.0	72.4	88.6	108.4	124.2	144.4
Air Factor	-	PCT (%)	95	1.86	1.86	1.86	1.86	1.86	1.86	1.86	1.86	1.86	1.86	1.89	2	NA	NA
			99.9	3.19	3.19	3.19	3.19	3.19	3.19	3.19	3.19	3.19	3.19	3.33	3.33	3.18	3.33
		PPM (%)	99.999	6.3	6.3	6.3	6.3	6.3	6.3	6.3	5.6	5.6	5.6	5.6	5.6	5.6	5.5
Pressure dewpoint outlet	°C /°F		-40	-40	-40	-40	-40	-40	-40	-40	-40	-40	-40	-40	-40	-40	-40
Maximum pressure drop		PCT (%)	95	0.4	0.4	0.4	0.5	0.5	0.5	0.6	0.6	0.6	0.6	0.6	0.9	0.9	NA
			99.9	0.3	0.3	0.3	0.3	0.3	0.3	0.3	0.3	0.3	0.3	0.3	0.5	0.5	0.6
		PCT (%)	99.999	0.2	0.2	0.2	0.2	0.2	0.2	0.2	0.2	0.2	0.2	0.2	0.2	0.3	0.3
Length	mm			775	775	775	775	775	775	1400	1400	1400	1400	1400	1400	1400	1400
	Inch			31	31	31	31	31	31	55	55	55	55	55	55	55	55
Width	mm			840	840	840	840	840	840	840	840	840	840	840	840	840	970
	Inch			33	33	33	33	33	33	33	33	33	33	33	33	33	38
Height	mm			2015	2015	2015	2015	2015	2015	2015	2015	2015	2015	2015	2015	2015	2015
	Inch			79	79	79	79	79	79	79	79	79	79	79	79	79	79
Mass	Kg			264	277	290	326	359	380	619	647	683	736	865	1038	1211	1211
	Lbs			582	611	639	719	791	838	1365	1426	1506	1623	1907	2288	2670	2670
Inlet and outlet connections	G/ NPT			1"	1"	1"	1"	1"	1"	1"	1"	1"	1"	1"	1"	1"	1"

1. Flow is measured at Reference Conditions: 1 bara and 20°C at operating pressure of 7 barg, inlet temperature 20°C & Air Inlet Quality of ISO 8573-1:2010 class 1-4-1

# PPNG 6 - 68 S - Nitrogen generator with pressure swing adsorption technology

## Features & Benefits

- ▶ Energy saving control
- ▶ Outstanding air factors thanks to back-flow pressurization
- ▶ High-quality, high-efficient Carbon Molecular Sieves selected for the right application
- ▶ Guaranteed purity
  - Zirconia sensors for reliable purity measurement
  - Dedicated high purity variants
  - Purity certificates
- ▶ Designed & tested for cyclic load
- ▶ Reliable, efficient and low-maintenance angle seat valves
- ▶ Carefully designed exhaust silencers resulting in quiet and safe operation of the generator
- ▶ Optimal control and monitoring thanks to Purelogic™ Controller

## General Specifications

- ▶ Pressure Swing Adsorption (PSA) nitrogen generators - extruded profile design
- ▶ Nitrogen purity achievable:  
95% - 99.9% (PCT Variant) & 99.95%-99.999% (PPM variant)
- ▶ Inlet pressure range: 4-13 barg /60-189 psig
- ▶ Inlet temperature range: 5-60°C/41-140°F
- ▶ Required inlet air quality:  
1-4-1 according to ISO 8573-1:2010
- ▶ Power supply: 115-230VAC/50-60Hz



## Options



Wooden packaging

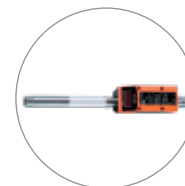

Flow meter



PDP sensor kit



The PPNG 6-68s series provides an efficient source of nitrogen for use in various industries like food and beverage, pharma, electronics and plastics. PPNG nitrogen generators use Pressure Swing Adsorption technology to extract nitrogen molecules from the compressed air; and can reach purities from 95% up to 99,999%. Nitrogen pressures can go up to 12 barg without the need for an additional booster. The air factors of the PPNG6-68s range are outstanding, making the return on investment very attractive compared to traditional gas supply.

With its PPNG 6-68s series, Pneumatech follows the plug and play philosophy. Pressure vessels, valves, exhaust system,

sensors and controls are all integrated within a compact canopy, designed for easy transport, installation and service.

The Purelogic™ is the central brain of the nitrogen generator. It optimizes operating costs thanks to the availability of the energy saving control; ensures maximum reliability by keeping track of the most important parameters of the generator; and offers impressive control and monitoring capabilities.

The optional flow meter and inlet pressure dew point sensor can be added to the scope of supply to further exploit the monitoring capabilities of the Purelogic™ controller.

Technical specifications for PPNG 6-68 S																		
Specifications	Units	Variant	Product → Purity ↓	PPNG 6S	PPNG 7S	PPNG 9S	PPNG 12S	PPNG 15S	PPNG 18S	PPNG 22S	PPNG 28S	PPNG 30S	PPNG 37S	PPNG 41S	PPNG 50S	PPNG 63S	PPNG 68S	
Nominal free nitrogen delivery <sup>(1)</sup>	m <sup>3</sup> /hr	PCT (%)	95	22.3	28.8	35.2	44.7	57.5	70.3	86.3	105.5	115.0	140.7	159.7	NA	NA	NA	
			99.9	5.9	7.6	9.3	11.8	15.2	18.6	22.8	27.9	30.4	37.2	45.6	55.8	59.1	64.7	
		PPM (%)	99.999	1.7	2.2	2.7	3.4	4.4	5.3	7.1	8.7	9.5	11.6	14.3	17.4	20.5	23.3	
Nominal air consumption <sup>(1)</sup>	m <sup>3</sup> /hr	PCT (%)	95	43.1	55.5	67.9	86.3	111.0	135.8	166.5	203.7	222.0	271.5	308.3	NA	NA	NA	
			99.9	23.9	30.8	37.7	47.9	61.6	75.3	92.4	113.0	123.2	150.7	182.5	223.3	226.8	258.6	
		PPM (%)	99.999	11.5	14.8	18.1	22.9	29.5	36.1	47.4	58.0	63.2	77.3	93.4	114.2	122.4	152.3	
Air Factor	-	PCT (%)	95	1.93	1.93	1.93	1.93	1.93	1.93	1.93	1.93	1.93	1.93	1.93	1.93	NA	NA	NA
			99.9	4.05	4.05	4.05	4.05	4.05	4.05	4.05	4.05	4.05	4.05	4.05	4.00	4.00	3.84	4.00
		PPM (%)	99.999	6.8	6.8	6.8	6.8	6.8	6.8	6.8	6.8	6.7	6.7	6.7	6.7	6.6	6.6	6.0
Pressure dewpoint outlet	°C /°F			-40	-40	-40	-40	-40	-40	-40	-40	-40	-40	-40	-40	-40	-40	
Maximum pressure drop	barg	PCT (%)	95	0.8	0.8	0.8	1	1	1.1	1.2	1.2	1.2	1.2	1.4	NA	NA	NA	
			99.9	0.5	0.5	0.5	0.6	0.6	0.7	0.7	0.7	0.7	0.7	0.9	0.9	0.9	1	
		PCT (%)	99.999	0.3	0.3	0.4	0.4	0.4	0.4	0.4	0.4	0.5	0.6	0.6	0.6	0.7	0.7	0.7
Length	mm			798	798	798	798	798	798	1422	1422	1422	1422	1422	1422	1422	1422	
	Inch			31	31	31	31	31	31	56	56	56	56	56	56	56	56	
Width	mm			840	840	840	840	840	840	840	840	840	840	970	970	970	970	
	Inch			33	33	33	33	33	33	33	33	33	33	38	38	38	38	
Height	mm			2022	2022	2022	2022	2022	2022	2022	2022	2022	2022	2022	2022	2022	2022	
	Inch			80	80	80	80	80	80	80	80	80	80	80	80	80	80	
Mass	Kg			244	257	270	306	339	360	599	627	663	716	805	1018	1191	1191	
	Lbs			538	567	595	675	747	794	1321	1382	1462	1579	1775	2244	2626	2626	
Inlet and outlet connections	G/NPT			1"	1"	1"	1"	1"	1"	1"	1"	1"	1"	1"	1"	1"	1"	

1. Flow is measured at Reference Conditions: 1 bara and 20°C at operating pressure of 7 barg, inlet temperature 20°C & Air Inlet Quality of ISO 8573-1:2010 class 1-4-1



## PPNG SKID - High-pressure nitrogen skid

### Are you looking for a true plug-and-play solution that delivers on-site nitrogen at the lowest cost?

Pneumatech has developed compact and pre-commissioned skids in two pressure versions.

The 40 barg version offers high-pressure nitrogen for direct use; with the 300 barg version you can fill the skid-mounted cylinders to create your own supply. These bottles can serve as your nitrogen back-up supply, but also allow you to downsize your system in case of fluctuating demand. With its supreme efficiency and reliability, ease of use and small footprint, the high-pressure skid is the ideal solution for laser cutting applications.

### Standard solution does not fit for your needs?

Do not worry. We at Pneumatech understand that every case is unique especially with high pressure Nitrogen applications. Therefore Pneumatech offers a tailor made solution just for your application.

Please consult with your local Pneumatech contact for more details.

#### PPNGs nitrogen generator

- ▶ Guaranteed purity
- ▶ Outstanding air factors
- ▶ Energy saving control
- ▶ Optimal control and monitoring thanks to Purelogic™ controller

#### 4-stage filter train for guaranteed purity and reliability

- ▶ General-purpose and high-efficient oil-coalescing filters, activated carbon tower and high-efficient particle filter
- ▶ Guaranteed air quality of class 1:4:1 (according to ISO8573-1:2010) at the inlet of the nitrogen generator

#### Variable speed compressor with integrated refrigerant dryer

- ▶ Closely follow the air demand by automatic adjustment of the motor speed
- ▶ Direct driven transmission for outstanding energy efficiency and reliability
- ▶ Very quiet operation due to improved noise insulation
- ▶ Compact design, also thanks to integrated refrigerant dryer



### Technical specifications for PPNG skid

Pneumatel variant	PPNG SKID 1	PPNG SKID 2	PPNG SKID 3	PPNG SKID 4	PPNG SKID 5	PPNG SKID 6	PPNG SKID 7	PPNG SKID 8	
N <sub>2</sub> Pressure	40 barg	40 barg	40 barg	40 barg	300 barg	300 barg	300 barg	300 barg	
N <sub>2</sub> Capacity <sup>(1)</sup> (m <sup>3</sup> /hr)	99.90%	10.5	21	42	73.1	13.4	21	42	73.1
	99.99%	5.3	10.5	22.1	41.1	6.7	10.5	22.1	41.1
Compressor with Integrated Dryer	8kW	11kW	22kW	36kW	8kW	11kW	22kW	36kW	
Filter train	G-C-VT-D	G-C-VT-D	G-C-VT-D	G-C-VT-D	G-C-VT-D	G-C-VT-D	G-C-VT-D	G-C-VT-D	
Air receiver	500L 11Bar CE Vessel	500L 11Bar CE Vessel	1000L 11Bar CE Vessel	1500L 11Bar CE Vessel	500L 11Bar CE Vessel	500L 11Bar CE Vessel	1000L 11Bar CE Vessel	1500L 11Bar CE Vessel	
N <sub>2</sub> Generator	PPNG9S PPM IEC	PPNG18S PPM IEC	PPNG37S PPM IEC	PPNG68S PPM IEC	PPNG12S PPM IEC	PPNG18S PPM IEC	PPNG37S PPM IEC	PPNG68S PPM IEC	
N <sub>2</sub> Receiver	500L 11Bar CE Vessel	500L 11Bar CE Vessel	1000L 11Bar CE Vessel	1500L 11Bar CE Vessel	500L 11Bar CE Vessel	500L 11Bar CE Vessel	1000L 11Bar CE Vessel	1500L 11Bar CE Vessel	
Particulate Filter	D	D	D	D	D	D	D	D	
N <sub>2</sub> Booster	15 hp 40 barg	15 hp 40 barg	15 hp 40 barg	15 hp 40 barg	10 hp 300 barg	10 hp 300 barg	15 hp 300 barg	2 x 15 hp 300 barg	
HP Storage	500L/45 barg	500L/45 barg	1000L/45 barg	1000L/45 barg	2 cylinder 300 barg	12 cylinder rack 300 barg	12 cylinder rack 300 barg	16 cylinder rack 300 barg	

1. Flow specified is at the outlet of the PPNGs Generator measured at Reference Conditions: 1 bara and 20°C at operating pressure of 7 barg, inlet temperature 20°C & Air Inlet Quality of ISO 8573-1:2010 class 1-4-1



#### Nitrogen storage: 40 barg receiver or 300 barg cylinders

- ▶ Bottle rack consisting of up to 16 high-pressure bottles
- ▶ Allows to shave peak demands

#### Nitrogen booster: 40 barg or 300 barg

- ▶ IE3-standard energy efficient motor
- ▶ Automatic condensate drain, reducing pressure losses by 80%
- ▶ Compressor block made of light alloys with high thermal efficiency, resulting in outstanding reliability
- ▶ Low noise levels thanks to sound insulated panels

# PPNG 150 - 800 HE - Nitrogen generators with pressure swing adsorption technology

## Features & Benefits

- ▶ Advanced energy saving control
  - Reduced air consumption at low nitrogen demand
  - Also compensates for altering ambient conditions and purity settings
  - No compressed air use when no nitrogen is consumed
- ▶ Outstanding air factors thanks to back-flow pressurization
- ▶ High-quality, high-efficient Carbon Molecular Sieves selected for the right application
- ▶ Guaranteed purity
  - Automatically regulates to the requested nitrogen pressure and purity
  - Zirconia sensors for reliable purity measurement
- ▶ Designed & tested for cyclic load
- ▶ Optimal control and monitoring thanks to Purelogic™ Controller
  - Self-protective monitoring of the feed air quality
  - Feed-air blow-off in case of contamination
  - Nitrogen flow, purity and pressure measured and controlled
  - Automatic start-up

## General Specifications

- ▶ Nitrogen purity achievable: 95%-99.9% (PCT Variant) & 99.95%-99.999% (PPM variant)
- ▶ Inlet pressure range: 5-10 barg/72-150 psig
- ▶ Ambient temperature range: 5-50°C/41-122°F
- ▶ Required inlet air quality: 1-4-1 according to ISO 8573-1:2010
- ▶ Power supply: 230VAC/50-60Hz



## Options



Wooden packaging



Outlet PDP sensor



The PPNG150-800 HE series is Pneumatech's premium on-site nitrogen solution for high flows, with best-in-class performance and the most complete scope of supply.

The generator has outstanding air factors at full load thanks to the use of highly efficient Carbon Molecular Sieves (CMS) and back-flow pressurization.

The air consumption is also optimized at reduced nitrogen flow or pressure demands, thanks to the advanced energy saving algorithm, which automatically adjusts the cycle times of the generator.

The control and monitoring capabilities of the PPNG150-800 HE are truly impressive. Purity is guaranteed at all times by opening the consumer valve only at the requested purity level and flushing nitrogen when purity is not reached. Feed air quality is controlled by monitoring temperature, pressure and PDP. The feed air is blown off in case of contamination. All risks of possible CMS damage are eliminated thanks to the automatic start-up feature.

Technical specifications for PPNG150 - 800 HE												
Specifications	Units	Variant	Product → Purity ↓	PPNG 150 HE	PPNG 200 HE	PPNG 250 HE	PPNG 300 HE	PPNG 350 HE	PPNG 400 HE	PPNG 500 HE	PPNG 650 HE	PPNG 800 HE
Nominal free Nitrogen delivery <sup>(1)</sup>	m <sup>3</sup> /hr	PCT(%)	95%	469	604	734	865	1063	1244	1607	2038	2592
			99.9%	169	218	265	312	384	449	580	735	935
		PPM	99.999%	75	96	117	138	169	198	253	321	408
Nominal air consumption <sup>(1)</sup>	m <sup>3</sup> /hr	PCT(%)	95%	886	1142	1387	1635	2010	2351	3036	3852	4898
			99.9%	549	708	859	1013	1245	1456	1881	2386	3034
		PPM	99.999%	377	486	590	695	854	999	1303	1653	2102
Air factor		PCT(%)	95%	1.9	1.9	1.9	1.9	1.9	1.9	1.9	1.9	1.9
			99.9%	3.2	3.2	3.2	3.2	3.2	3.2	3.2	3.2	3.2
		PPM	99.999%	5.1	5.1	5.1	5.1	5.1	5.1	5.2	5.2	5.2
Pressure dewpoint outlet (°C)		°C/°F		-40	-40	-40	-40	-40	-40	-40	-40	-40
Maximum pressure drop (barg)		PCT(%)	95-99.9%	1,5 - 1	1,5 - 1	1,5 - 1	1,5 - 1	1,5 - 1	1,5 - 1	1,5 - 1	1,5 - 1	1,5 - 1
		PPM	99.95% - 99.999%	0.5	0.5	0.5	0.5	0.5	0.5	0.5	0.5	0.5
Length	mm			1800	1800	1800	2300	2300	2300	3120	3120	3120
	Inch			70.9	70.9	70.9	90.6	90.6	90.6	122.8	122.8	122.8
Width	mm			2230	2570	2650	2720	2850	2900	3660	3760	3860
	Inch			87.8	101.2	104.3	107.1	112.2	114.2	144.1	148.0	152.0
Height	mm			2610	2640	2625	3020	3050	3040	3970	4175	4405
	Inch			102.8	103.9	103.3	118.9	120.1	119.7	156.3	164.4	173.4
Mass	Kg			3200	3800	4800	6400	7000	7700	10300	12000	14200
	lbs			7054.8	8377.6	10582.2	14109.6	15432.3	16975.6	22707.6	26455.4	31305.6
N2 & Air Receiver size	liters			3000	4000	5000	6000	8000	8000	12000	16000	20000
Nitrogen to buffer connection	DN			80	80	80	80	80	80	100	100	100
Nitrogen from buffer connection	DN	PCT(%)	95-99.9%	50	50	50	80	80	80	100	100	100
		PPM	99.95% - 99.999%	40	40	40	40	40	40	50	50	50
Nitrogen outlet connection	DN	PCT(%)	95-99.9%	50	50	50	80	80	80	100	100	100
		PPM	99.95% - 99.999%	50	50	50	50	50	50	50	50	50
Waste gas blow-off	mm			315	315	315	400	400	400	600	600	600

1. Flow is measured at Reference Conditions: 1 bara and 20°C at operating pressure of 7 barg, inlet temperature 20°C & Air Inlet Quality of ISO 8573-1:2010 class 1-4-1

# PMNG 1-3 - Nitrogen generator with membrane technology

## Features & Benefits

- ▶ High Quality membrane separator
  - Superior membrane constructed from high quality Aluminum with technically advance fiber.
  - N<sub>2</sub> Generation is achieved without any moving part
  - Outstanding performance for 90-99,5% Nitrogen separation
- ▶ Simple, reliable and user friendly
  - All-in-one plug & play solution
  - All filters integrated in enclosed canopy design
  - Instant supply of nitrogen
  - No specialist installation or commissioning
- ▶ 3-stage pre-filtration integrated in the canopy
- ▶ No power supply required thanks to Pneumatic controlled valves & battery-powered nitrogen analyzer
- ▶ Guaranteed purity
  - Nitrogen analyzer (battery powered) with auto-calibration button (optional)
  - Purity controller to ensure constant N<sub>2</sub> purity at all times
- ▶ Compressed Air savings when desired purity is reached
  - Economizer (pneumatic) automatically stops air consumption when target pressure is reached

## General Specifications

- ▶ Membrane Nitrogen Generators
- ▶ Nitrogen purity achievable: 90%-99.5%
- ▶ Inlet pressure range: 4-13 bar/60-189 PSI
- ▶ Inlet temperature range: 5-50°C/41-122°C
- ▶ Required inlet air quality: 1-4-1 according to ISO 8573-1:2010



## Options



Economizer



Nitrogen analyser  
(battery powered)



Mobile  
version



Pneumatech's new smaller range of PMNG nitrogen generators utilizes proprietary membrane separation technology. Membrane generators are an excellent choice in low (90%) to medium (99,5%) purity applications such as tire inflation, fire prevention, tank blanketing and pipeline drying. Nitrogen pressures can go up to 12 bar (g) without the need for an additional booster.

Engineered for simplicity, durability and ease of use make the PMNG what we believe to be the most user friendly unit in the market. All pre-filters and controls are included inside the canopy. Only a supply of dry compressed air is needed to get nitrogen at the outlet of the generator. Also the start-up procedure of the PMNG is made so straightforward that it does not require any specialist.

Pneumatech offers a purity controller that delivers true consistent purity downstream in ANY flow situation. Our simple design allows adjustments to be made easily, with a single screw. The purity is reliably monitored thanks to the optional battery operated Nitrogen Analyser. The optional Economiser system is designed to save the utility costs of operating the compressor and reduces the wear and tear on Air and Nitrogen Systems.

This cost effective solution from Pneumatech significantly reduces Nitrogen costs over traditional sources of Nitrogen supply.

Technical specifications for PMNG 1-3					
Specifications	Units	Product → Purity ↓	PMNG 1	PMNG 2	PMNG 3
Nominal air consumption	Nm <sup>3</sup> /hr	90%	15.48	30.96	46.44
		95%	9.72	19.44	29.16
		96%	9	18	27
		97%	7.56	15.12	22.68
		98%	6.84	13.68	16.92
		99%	6.12	12.24	18.36
		99.5%	5.76	11.52	17.28
Nominal free nitrogen delivery	Nm <sup>3</sup> /hr	90%	10.08	20.16	30.24
		95%	4.68	9.36	14.04
		96%	3.96	7.92	11.88
		97%	3.24	6.48	9.72
		98%	2.52	5.04	7.56
		99%	1.8	3.6	5.4
		99.5%	1.44	2.88	4.32
Air factor	-	90%	1.5	1.5	1.5
		95%	2.1	2.1	2.1
		96%	2.3	2.3	2.3
		97%	2.3	2.3	2.3
		98%	2.7	2.7	2.7
		99%	3.4	3.4	3.4
		99.5%	4.0	4.0	4.0
Pressure dewpoint outlet	°C /°F		-40	-40	-40
Length	mm		560.0	560.0	560.0
	Inch		22.0	22.0	22.0
Width	mm		285.0	285.0	285.0
	Inch		11.0	11.0	11.0
Height	mm		1150.0	1150.0	1150.0
	Inch		45.0	45.0	45.0
Mass	Kg		60.0	62.0	65.0
	Lbs		132.3	136.7	143.3
Inlet connections	G		G1/2"	G1/2"	G1/2"
Outlet connections	G		G1/2"	G1/2"	G1/2"

1. Flow is measured at reference conditions: 1 Bar(a) and 20°C at operating pressure of 8 bar (g), inlet temperature 20°C & Air Inlet Quality of ISO 8573-1:2010 class 1-4-1.

# PMNG 5 - 75 S - Nitrogen generator with membrane technology

## Features & Benefits

- ▶ Energy-saving control
- ▶ Proprietary membrane technology ensuring lasting performance
  - No aging
  - No heater
- ▶ Guaranteed purity
  - Reliable purity measurement
  - Easy to set up the device for purity levels between 95% and 99.5%
- ▶ All-in-one plug & play solution
  - All filters integrated in enclosed canopy design
  - No buffer vessels required
  - Instant supply of nitrogen
  - No specialist installation or commissioning
- ▶ Optimal control and monitoring thanks to Purelogic™ Controller

## General Specifications

- ▶ Membrane Nitrogen Generators
- ▶ Nitrogen purity achievable: 95%-99.5%
- ▶ Inlet pressure range:  
4-13 barg/60-189 psig
- ▶ Inlet temperature range:  
5-50°C/41-122°F
- ▶ Required inlet air quality:  
1-4-1 according to ISO 8573-1:2010
- ▶ Power supply: 115-230VAC/50-60Hz



## Options



Oil indicator



Flow sensor



PDP sensor kit

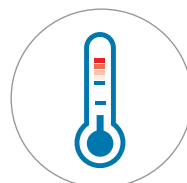

High ambient  
temperature  
software

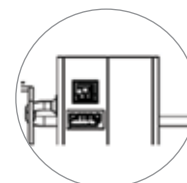

Permeate vent kit





Pneumatech's PMNG nitrogen generators utilize proprietary membrane separation technology. Membrane generators are an excellent choice in low (95%) to medium (99,5%) purity applications such as tire inflation, fire prevention, tank blanketing and pipeline drying. Nitrogen pressures can go up to 12 barg without the need for an additional booster.

With the PMNG, on-site nitrogen supply becomes exceptionally convenient. All pre-filters and controls are included inside the canopy. Only a supply of dry compressed air and electricity is needed to get nitrogen at the outlet of the generator. An outlet buffer vessel is not required, which results in significant space

savings and easy installation. Also the start-up procedure of the PMNG is made so straightforward that it does not require any specialist.

Thanks to the Purelogic™ controller, the PMNG offers impressive control and monitoring capabilities. Various pressure and temperature sensors ensure that the membranes are used in the right working conditions. The nitrogen purity can easily be set with the purity regulator and is reliably monitored. The optional pressure dew point (PDP) sensor and oil indicator sensor safeguard air purity of class 1:4:1 according to ISO8573-1:2010 at the inlet of the membranes.

Technical specifications for PMNG 5-75 S									
Specification	Unit	Product Purity	PMNG5s	PMNG10s	PMNG15s	PMNG30s	PMNG45s	PMNG60s	PMNG75s
Nominal free nitrogen delivery <sup>(1)</sup>	m <sup>3</sup> /hr	95%	11.9	24.1	42.1	83.9	126.0	168.1	209.9
		96%	9.7	19.4	34.6	69.5	104.0	138.6	173.2
		97%	7.6	15.1	27.4	54.7	82.1	109.1	136.4
		98%	5.4	10.8	19.8	40.0	59.8	79.9	99.7
		99%	3.6	6.8	11.5	23.0	34.6	46.1	57.6
		99.5%	2.5	5.0	7.2	14.8	22.0	29.5	36.7
Nominal air consumption <sup>(1)</sup>	m <sup>3</sup> /hr	95%	31.0	62.3	109.1	218.5	327.6	436.7	546.1
		96%	29.2	58.0	104.0	208.1	311.8	415.8	519.8
		97%	26.6	52.9	95.4	191.2	286.6	382.3	477.7
		98%	23.4	47.2	85.7	171.7	257.4	343.1	428.8
		99%	22.0	43.6	72.7	145.4	218.2	291.2	364.0
		99.5%	21.6	42.8	62.6	124.9	187.6	249.8	312.5
Air factor		95%	2.6	2.6	2.6	2.6	2.6	2.6	2.6
		96%	3	3	3	3	3	3	3
		97%	3.5	3.5	3.5	3.5	3.5	3.5	3.5
		98%	4.3	4.3	4.3	4.3	4.3	4.3	4.3
		99%	6.3	6.3	6.3	6.3	6.3	6.3	6.3
		99.5%	8.5	8.5	8.5	8.5	8.5	8.5	8.5
Pressure dewpoint outlet	°C /°F		-40	-40	-40	-40	-40	-40	-40
Length	mm		820	820	820	820	820	820	820
	inch		32.3	32.3	32.3	32.3	32.3	32.3	32.3
Width	mm		772	772	772	1470	1470	1470	1470
	inch		30.4	30.4	30.4	57.9	57.9	57.9	57.9
Height	mm		2090	2090	2090	2090	2090	2090	2090
	inch		82.3	82.3	82.3	82.3	82.3	82.3	82.3
Mass	Kg		259	268	285	445	497	535	571
	Lbs		571	590	628	981	1096	1179	1259
Inlet connections	G/NPT		1/2"	1/2"	1/2"	1 1/2"	1 1/2"	1 1/2" - 1"	1 1/2" - 1"
Outlet Connections	G/NPT		1/2"	1/2"	1/2"	1"	1"	1"	1"

1. Flow is measured at Reference Conditions: 1 bara and 20°C at operating pressure of 8 barg, inlet temperature 20°C & Air Inlet Quality of ISO 8573-1:2010 class 1-4-1



# PPOG 1 - 120 - Oxygen generator with pressure swing adsorption technology

## Features & Benefits

- ▶ Energy saving control
- ▶ High-quality, high-efficient zeolite, selected for the right application
- ▶ Guaranteed purity
  - Zirconia sensors for reliable purity measurement
- ▶ Designed & tested for cyclic load
- ▶ Optimal control and monitoring thanks to Purelogic™ Controller
- ▶ Available with IEC and CSA/UL approvals

## General Specifications

- ▶ Pressure Swing Adsorption (PSA) Oxygen Generators - welded vessels
- ▶ Oxygen purity achievable: 90%-95%
- ▶ Inlet pressure range: 4-7.5 barg /58-109 psig
- ▶ Inlet temperature range: 5-45°C/41-113 psig
- ▶ Required inlet air quality: 1-4-1 according to ISO 8573-1:2010
- ▶ Power supply: 115-230VAC/50-60Hz



## Options



Seaworthy packaging



PDP sensor kit



Oxygen buffer vessels



Pneumatech gives oxygen to your business. With the PPOG range, Pneumatech offers an attractive replacement for traditional oxygen supply with very interesting returns on investment. The PPOG1-120 series uses Pressure Swing Adsorption technology to extract oxygen from compressed air, resulting in oxygen purity levels up to 95%.

The PPOG1-120 range is a welded vessel design, designed and tested for cyclic load. The Purelogic™ is the central brain of the generator. It optimizes operating costs thanks to the availability of the energy saving control; ensures maximum reliability by

monitoring the most important parameters of the generator; and offers impressive control and monitoring capabilities.

The calibrated flow meters are part of the standard scope of supply, in order to facilitate the start-up process and to provide transparency of the actual oxygen consumption. The optional oxygen buffer vessel is equipped with a pressure regulator, manometer and dust filter. Each of these components is approved for high-purity oxygen use. The optional inlet pressure dew point sensor provides additional security in case the upstream dryer would fail.

Technical specifications for PPOG 1-120																						
Specifications	Units	Product Purity ↓	PPOG 1	PPOG 1.5	PPOG 2	PPOG 3	PPOG 4	PPOG 5	PPOG 6	PPOG 8	PPOG 11	PPOG 12	PPOG 14	PPOG 17	PPOG 20	PPOG 26	PPOG 33	PPOG 39	PPOG 50	PPOG 63	PPOG 93	PPOG 120
Nominal free oxygen delivery <sup>(1)</sup>	m <sup>3</sup> /hr	90%	2.0	3.1	3.8	4.6	6.6	7.9	9.7	14.2	18.5	20.3	23.4	29.3	35.1	45.3	56.0	66.1	85.5	106.8	157.7	203.5
		93%	1.6	2.5	3.5	4.3	5.6	7.3	9.0	13.4	18.3	19.3	21.4	27.6	33.0	42.7	51.9	64.1	79.4	101.7	154.6	188.2
		95%	1.5	2.3	3.4	4.0	5.4	6.9	8.3	12.2	15.4	18.3	20.3	26.3	31.6	39.2	48.8	57.0	74.3	93.6	143.4	175.0
Nominal air consumption	m <sup>3</sup> /hr	90%	22.6	30.5	36.6	54.9	73.3	103.8	103.8	157.5	192.3	219.8	256.4	329.6	366.3	518.9	634.8	799.6	982.8	1245.3	1867.9	2246.3
		93%	22.0	29.9	36.0	53.7	67.1	100.7	102.6	146.5	189.2	213.6	244.2	319.9	355.3	512.8	604.3	781.3	964.5	1220.8	1953.3	2228.0
		95%	21.4	28.7	35.4	51.9	65.9	97.7	102.6	140.4	170.9	207.5	238.1	313.1	347.9	500.5	586.0	763.0	915.6	1159.8	1892.3	2197.5
Average air / oxygen ratio		90%	11.1	10.0	9.7	12.0	11.1	13.1	10.7	11.1	10.4	10.8	11.0	11.3	10.4	11.5	11.3	12.1	11.5	11.7	11.8	11.0
		93%	13.5	11.8	10.4	12.6	12.0	13.8	11.5	10.9	10.3	11.1	11.4	11.6	10.8	12.0	11.6	12.2	12.2	12.0	12.6	11.8
		95%	14.0	12.3	10.5	13.1	12.2	14.1	12.3	11.5	11.1	11.3	11.7	11.9	11.0	12.8	12.0	13.4	12.3	12.4	13.2	12.6
Pressure dewpoint outlet (°C)	°C / °F	-40	-40	-40	-40	-40	-40	-40	-40	-40	-40	-40	-40	-40	-40	-40	-40	-40	-40	-40	-40	-40
Oxygen outlet quality		ISO8573-1:2010 Class 1-2-1																				
Length	mm	600.0	600.0	750.0	750.0	850.0	850.0	1120.0	1120.0	1190.0	1230.0	1230.0	1640.0	1765.0	1960.0	1960.0	1960.0	2470.0	2920.0	2470.0	2920.0	
	Inch	23.6	23.6	29.5	29.5	33.5	33.5	44.1	44.1	46.9	48.4	48.4	64.6	69.5	77.2	77.2	77.2	97.2	115.0	97.2	115.0	
Width	mm	757.0	757.0	770.0	770.0	848.0	848.0	875.0	875.0	924.0	943.0	947.0	1108.0	1135.0	1175.0	1175.0	1305.0	1440.0	2610.0	2880.0		
	Inch	29.8	29.8	30.3	30.3	33.4	33.4	34.4	34.4	36.4	37.1	37.3	43.6	44.7	46.3	46.3	51.4	56.7	102.8	113.4		
Height	mm	1467.0	1489.0	1801.0	1801.0	1630.0	1630.0	1962.0	1962.0	2252.0	2278.0	2678.0	2450.0	2492.0	3094.0	3094.0	3592.0	3097.0	3280.0	3097.0	3280.0	
	Inch	57.8	58.6	70.9	70.9	64.2	64.2	77.2	77.2	88.7	89.7	105.4	96.5	98.1	121.8	121.8	141.4	121.9	129.1	121.9	129.1	
Mass	Kg	193.8	226.8	324.8	330.6	412.6	412.6	723.0	735.0	1009.3	1192.3	1321.2	2359.3	2632.7	3150.0	3150.0	3681.0	4908.0	6489.0	9746.0	12470.0	
	Lbs	427.3	500.0	716.1	728.9	909.6	909.6	1593.9	1620.3	2225.1	2628.5	2912.7	5201.4	5804.1	6944.6	6944.6	8115.2	10820.3	14305.8	21486.2	27491.6	
Inlet connections	G/ NPT	G1/2"	G1/2"	G1/2"	G1/2"	G1/2"	G1/2"	G 3/4"	G 3/4"	G1"	G1"	G1"	G1 1/2"	G1 1/2"	DN50	DN50	DN50	DN50	DN50	2xDN50	2xDN50	
Outlet connections	G/ NPT	G3/8"	G3/8"	G3/8"	G3/8"	G3/8"	G3/8"	G1/2"	G1/2"	G1/2"	G1/2"	G1/2"	G 3/4"	G 3/4"	G 3/4"	G 3/4"	G 3/4"	G 3/4"	G 3/4"	G 3/4"	2xG3/4"	2xG3/4"

1. Flow is measured at Reference Conditions: 1 bara and 20°C at operating pressure of compressed air of 6 barg and oxygen pressure at the outlet 4.5 barg, inlet temperature 20°C & Air Inlet Quality of ISO 8573-1:2010 class 1-4-1

## Oxygen solutions

Pneumatech offers packaged solutions for on-site oxygen generation, which guarantee peace-of-mind and quick returns compared to traditional oxygen supply.

A typical lineup consists of a compressor, a refrigerant dryer, filters, buffer vessels and a PPOG oxygen generator; and can be completed with a high-pressure oxygen booster and a bottle filling station. These can be containerized or skid-mounted, depending on the application and the needs.



**DO YOU  
KNOW THAT?**

Our boosters are available in 3 kW to 15 kW models and can safely and reliably boost oxygen, nitrogen, helium or argon up to 200 barg / 2900 psig. By boosting a gas to these high pressures, you can bottle the gas you generate. This is particularly interesting to cover peak demand or as emergency back-up.



Pneumatech's on-site oxygen systems generate oxygen from 90% up to 95% purity, and are thus compliant with European pharmacopeia and United States Pharmacopeia (USP). Our production locations are moreover certified according to ISO 13485, the international quality management system for medical devices.



## Keeps the pressure up

Did you know that a pressure drop of 1 bar results in a 7% increase of your energy consumption? To avoid such losses you need to ensure that your piping system is properly sized, leak-free and retains the pressure. AIRnet is an engineered piping system that can be sized and planned to deliver the desired pressure for a variety of high performing applications.



# Piping systems

The optimal piping network is sized, planned and installed to support sustainable operational excellence in the production process. Material and product design, installation and maintenance costs, flexibility and safety. They all influence your total cost of ownership and the level of efficiency in your production. If you are looking for a high performing and effortless system that can be customized to fit any production site, AIRnet will turn out to be the best investment choice you can make.

# AIRnet - Aluminium range

## Features and Benefits

- ▶ Time and tooling
  - Quick connections with no need to crimp, thread, solder or glue the pipe
  - No heavy tooling or machinery required
  - PF series and black series can be connected to any existing network via simple use of adaptor unions and nipple sockets
  - PF series is assembled by hand, a push of the pipe into the fitting is all it takes
- ▶ Modularity
  - Easy to handle and easy to work with lightweight materials
  - Modular design supports extensions and modifications to meet new demands
  - Components are interchangeable and reusable after disassembly
  - Quickdrops are easily mounted, both horizontally and vertically
- ▶ Sustainability
  - Optimized inner body design minimizes flow resistance and pressure drop in the fittings
  - Low friction factor and seamless connections minimize pressure drops in the pipe network
  - Superior sealing technology ensures a leak free system and maintains performance over time
  - Durable and corrosion resistant materials offers a maintenance free system
- ▶ Safety
  - Safety factor of 4 for all diameters (burst pressure)
  - Camera control and automatic assembly guarantee zero defect manufacturing
  - Plastic components and pipe clips comply to UL 94 HB and UL 94 V-2 for flammability
  - Torque indicators ensure sufficient torquing



## Options



Fittings



Fittings



White torque indicators



Aluminium  
RAL 5012



Aluminium  
RAL 6018



### Pipes 20 (¾") - 25 (1") - 40 (1 ½") - 50 (2") - 63 (2 ½") - 80 (3") - 100 (4") - 158 (6") mm

Applications	Compressed Air and Vacuum	EN standard
Additional gasses	Nitrogen, Helium, Argon, Neon, Xenon and Krypton	-
Material	Extruded aluminum alloy EN AW-6060 T6 (similar to alloy 6063T5)	EN 755-2 (ASTM B241)
Safety factor	4 for all diameters (burst pressure)	(Calculated according to ASME B31.1)
Working pressure	Max 16 bar(g) (Max 232 psig)	-
Working temperature	-20°C to 80°C (-4°F to 176°F)	-
Vacuum level	13 mbar(a) (0.189 psia)	-
Dewpoint	Lowest allowable pressure dewpoint is -70°C (-94°F)	-
Outside treatment	Polyester powder paint (QUALICOAT certified)	-
Inside treatment	Chrome free conversion treatment	-
Colors	Blue RAL 5012 and Green RAL 6018 : only 20-25mm (¾"-1")	-

### Fittings 20 (¾") - 25 (1") - 40 (1 ½") - 50 (2") mm (pf series)

Connection	Push to fit technology	EN standard
Materials	Engineered polymer PA6 - GF30 fiberglass reinforcement Aluminum high pressure die casting EN AC-46100 (Similar to A03830) Wrought aluminum alloy EN AW-6026 (Similar to alloy 6082)	EN 1706 (ASTM B85) EN 755-2 (ASTM B221)
Seal fittings	NBR 70 Sh A (PTFE coating on pipe seal)	-

### Fittings 63 (2 ½") - 80 (3") mm (black series)

Connection	Torque to grip technology	EN standard
Materials	Aluminum high pressure die casting EN AC-46100 (Similar to A03830) Aluminum permanent mold casting EN AC-43100 (Similar to A13600) Wrought aluminum alloy EN AW-6026 (Similar to alloy 6082)	EN 1706 (ASTM B85) EN 1706 (ASTM B85) EN 755-2 (ASTM B221)
Seal fittings	NBR 70 Sh A	-

### Fittings 100 (4") - 158 (6") mm

Connection	Bolt clamp technology	EN standard
Materials	Aluminum permanent mold casting EN AC-43100 (Similar to A13600) Stainless Steel EN 1.4301 (Similar to alloy 304)	EN 1706 (ESTM B85) EN 10088-2 (AISI 304)
Seal fittings	NBR 70 Sh A	-



## AIRnet - Stainless steel range

AIRnet stainless steel is a piping system designed to deliver a fast, easy, reliable and clean distribution network for compressed air, nitrogen, vacuum specifically for industries that demand the highest quality of air.

### Features and Benefits

- No corrosion, leak resistant and 10 year guarantee
  - Press fit system ensures fast installation with minimal tools
  - No welding, no threading: just push & press
  - Silicone free system
  - FKM Seal (approved by all international regulating bodies for Pharma, F&B)
  - Can be used for clean room applications (316 L)
  - Considerable savings on the labor cost
- ▶ Advantage of press connection
- 20% enlargement of the sealing surface area with a security seal ring minimizes the risk of accidents
  - Eliminates the risk of sealing ring being pressed out or damaged
  - The fit between the sealing ring and the groove makes the pipes insertion easier.



Airnet product information		
Product range	Pipes SS304L: D15 (½"), D28 (1"), D35 (1 ¼"), D42 (1 ½"), D54 (2"), D76 (2 ¾"), D89 (3 ½"), D108 (4") Pipes SS316L: D15 (½"), D28 (1"), D42 (1 ½")	-
Applications	Compressed Air, Nitrogen, Vacuum...	-
Material	Stainless Steel AISI 304L 1.4301 Stainless Steel AISI 316L 1.4404	EN10088 ASTM A666
Safety factor	4, Burst pressure > 64 Bar (> 928 PSI)	-
Working pressure	16 Bar (232 PSI)	-
Working temperature	-20°C to 120°C (-4°F to 248°F)	-
Vacuum level	20 mbar (0.29 PSI) abs	-
Dewpoint	Lowest allowable pressure dewpoint is -70°C (-94°F)	-
Treatment	Annealing	-
Fittings	D15 (½"), D28 (1"), D35 (1 ¼"), D42 (1 ½"), D54 (2"), D76 (2 ¾"), D89 (3 ½"), D108 (4")	-
Connection	Press fit system	-
Materials	Stainless steel AISI 316L 1.4404	EN10088 ASTM A666
Seal fittings	FKM (fluoroelastomer)	-



## The versatility of air receivers

One or more air receivers are included in each compressor installation. The size is adapted, e.g. according to the compressor capacity, regulation system and the consumer's air requirement.

The air receiver forms a storage area for the compressed air, balances pulsation from the compressor and cools the air and collects condensation. Accordingly, the air receiver must be fitted with a drainage device.



# Air Receivers

Pneumatech offers receivers in a large variety of sizes and treatments to suit your needs. These can be used for compressed air or inert gases like nitrogen.

## V Range - Air & nitrogen receivers

### Features and Benefits

- ▶ Available in variety of sizes and treatments to suit your needs
  - Painted vessels
  - Galvanized vessels
  - Vitrified vessels
- ▶ Equipped with connection kit as standard up to 3000 liters
  - Including pressure gauge, safety valves, and ball valves.
- ▶ Vitroflex vessels are 100% water and steam resistant

### General Specifications

- ▶ Types: painted - galvanized - vitrified (Vitroflex)
- ▶ Max. pressure:
  - Standard range: 11 barg/160 psig  
Note: Each size will have different pressure rating.  
Refer table for specific details
  - High pressure range: 16 barg/232psig
- ▶ Volume:
  - 100 - 5000 liters for standard range
  - 500 - 5000 liters for high pressure range

Vessels have several functions: they stabilize pressure peaks and provide thus a stable air- or nitrogen flow; have a storage function in case of a high consumption; and help with the preliminary separation and removal of condensate.

Pneumatech offers a wide range of vessels capable of handling pressures up to 16 barg / 232 psig. They are available in 3 types: painted, galvanized and vitrified. Painted vessels are generally used where receivers are not subjected to extreme weather conditions and perfectly clean air is not an absolute requirement. Galvanized vessels are used when there is a possibility of corrosion. Vitrified vessels (Vitroflex) are treated with vitreous enamel, which makes them 100% water and steam resistant.



### Options



Connection kit



Painted standard vessels												
Variant	V100	V200	V270	V500	V720	V900	V1000	V1500	V2000	V3000	V4000	V5000
Capacity (L)	100	200	270	500	720	900	1000	1500	2000	3000	4000	5000
Pressure (barg)	11	11	11	11	10,8	11	12	11,5	11,5	11,5	11,5	11,5
Diameter Ø	370	446	500	600	750	800	800	1000	1000	1200	1450	1450
H tot (mm)	1172	1570	1668	2055	2030	2120	2315	2305	2805	2965	3070	3570
h (mm)	124	174	170	155	150	130	115	180	180	185	180	180
a	3/4"	1"	1"	1"	1"	1"1/2	2"	2"	2"	3"	3"	3"
b	3/4"	1"	1"	1"	1"	1"1/2	2"	2"	2"	3"	3"	3"
c	3/8"	3/8"	3/8"	3/8"	3/8"	3/8"	3/8"	3/4"	3/4"	3/4"	3/4"	3/4"
d	3/8"	3/8"	n.d.	n.d.	3/8"	3/8"	3/8"	3/8"	3/8"	3/8"	3/8"	3/8"
e	1/2"	1/2"	1/2"	2"	2"	2"	2"	1"1/4	1"1/4	1"1/4	1"1/4	1"1/4
f	1/2"	1/2"	1/2"	2"	2"	2"	2"	1"1/4	1"1/4	1"1/4	1"1/4	1"1/4
l (mm)	298	397	599	775	895	860	745	590	595	700	780	780
m (mm)	998	1222	1304	1560	1705	1780	1685	1860	2355	2410	2430	2930
Kit type included	1	2	3	4	4	6	7	B	B	B	Not included	
Weight (kg)	37	51	62	127	180	200	204	278	352	537	802	923
Applicable directive	2014/29/EU						2014/68/EU (PED)					

Galvanized standard vessels												
Variant	V100	V200	V270	V500	V720	V900	V1000	V1500	V2000	V3000	V4000	V5000
Capacity (L)	100	200	270	500	720	900	1000	1500	2000	3000	4000	5000
Pressure (barg)	11	11	11	11	10,8	11	11,5	11,5	11,5	11,5	11,5	11,5
Diameter Ø	370	430	500	600	790	790	790	1000	1000	1200	1450	1450
H tot (mm)	1229	1530	1685	2077	1863	2213	2345	2305	2805	2965	3070	3570
h (mm)	176	135	192	174	200	200	200	180	180	185	180	180
a	3/4"	3/4"	3/4"	1"1/2	1"1/2	2"	2"	2"	2"	3"	3"	3"
b	3/4"	3/4"	3/4"	1"1/2	1"1/2	2"	2"	2"	2"	3"	3"	3"
c	3/8"	3/4"	3/4"	3/4"	3/4"	3/4"	3/4"	3/4"	3/4"	3/4"	3/4"	3/4"
d	3/8"	3/8"	3/8"	3/8"	3/8"	3/8"	3/8"	3/8"	3/8"	3/8"	3/8"	3/8"
e	2"	2"	1"1/4	1"1/4	1"1/4	1"1/4	1"1/4	1"1/4	1"1/4	1"1/4	1"1/4	1"1/4
f	2"	2"	1"1/4	1"1/4	1"1/4	1"1/4	1"1/4	1"1/4	1"1/4	1"1/4	1"1/4	1"1/4
l (mm)	447	397	442	689	690	800	725	590	595	700	780	780
m (mm)	1055	1280	1422	1689	1440	1800	1725	1860	2355	2410	2430	2930
Kit type included	1	A	A	A	A	A	B	B	B	B	Not included	
Weight (kg)	40	55	66	143	184	209	224	306	387	591	882	1025
Applicable directive	2014/29/EU						2014/68/EU (PED)					

Vitroflex standard vessels												
Variant	V100	V200	V270	V500	V720	V900	V1000	V1500	V2000	V3000	V4000	V5000
Capacity (L)	100	200	270	500	720	900	1000	1500	2000	3000	4000	5000
Pressure (barg)	N.A.	11	11	11	10,8	11	11,5	11,5	11,5	11,5	11,5	11,5
Diameter Ø	N.A.	430	500	600	790	790	790	1000	1000	1200	1450	1450
H tot (mm)	N.A.	1530	1685	2077	1863	2213	2345	2305	2805	2965	3070	3570
h (mm)	N.A.	135	192	174	200	200	200	180	180	185	180	180
a	N.A.	3/4"	3/4"	1"1/2	1"1/2	2"	2"	2"	2"	3"	3"	3"
b	N.A.	3/4"	3/4"	1"1/2	1"1/2	2"	2"	2"	2"	3"	3"	3"
c	N.A.	3/4"	3/4"	3/4"	3/4"	3/4"	3/4"	3/4"	3/4"	3/4"	3/4"	3/4"
d	N.A.	3/8"	3/8"	3/8"	3/8"	3/8"	3/8"	3/8"	3/8"	3/8"	3/8"	3/8"
e	N.A.	2"	1"1/4	1"1/4	1"1/4	1"1/4	1"1/4	1"1/4	1"1/4	1"1/4	1"1/4	1"1/4
f	N.A.	2"	1"1/4	1"1/4	1"1/4	1"1/4	1"1/4	1"1/4	1"1/4	1"1/4	1"1/4	1"1/4
l (mm)	N.A.	397	442	689	690	800	725	590	595	700	780	780
m (mm)	N.A.	1280	1422	1689	1440	1800	1725	1860	2355	2410	2430	2930
Kit type included	N.A.	A	A	A	A	A	B	B	B	B	not included	
Weight (kg)	N.A.	50	60	130	167	190	204	278	352	537	802	932
Applicable directive	2014/29/EU						2014/68/EU (PED)					

## V HP - Air & nitrogen receivers

Painted high pressure vessels

Capacity (L)	500	1000	2000	3000	4000	5000
Pressure (barg)	16	16	16	16	16	16
Diameter Ø	600	800	1000	1200	1430	1430
H tot (mm)	2055	2315	2810	2930	3110	3610
h (mm)	155	115	175	170	190	190
a	1"	2"	2"	2"	2"	2"
b	1"	2"	2"	2"	2"	2"
c	n.d.	3/8"	3/4"	3/4"	3/4"	3/4"
d	3/8"	3/8"	3/8"	3/8"	3/8"	3/8"
e	2"	2"	2"	2"	2"	2"
f	2"	2"	2"	2"	2"	2"
l (mm)	775	745	565	645	765	765
m (mm)	1560	1685	2340	2370	2450	2950
Kit type included	5	8	C	C	Not included	
Weight (kg)	159	246	490	620	905	1055
Applicable directive	2014/29/EU		2014/68/EU (PED)			

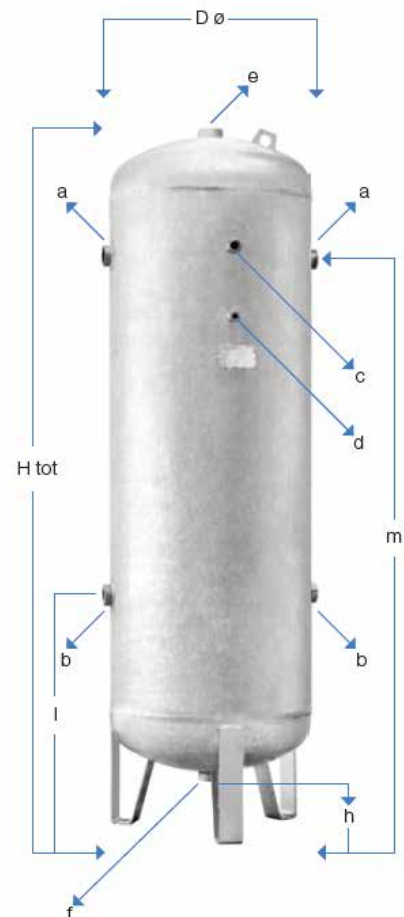



### Galvanized high pressure vessels

Capacity (L)	500	1000	2000	3000	4000	5000
Pressure (barg)	16	16	16	16	16	16
Diameter Ø	600	790	1000	1200	1430	1430
H tot (mm)	2120	2365	2810	2930	3110	3610
h (mm)	175	200	175	170	190	190
a	2"	2"	2"	2"	2"	2"
b	2"	2"	2"	2"	2"	2"
c	3/4"	3/4"	3/4"	3/4"	3/4"	3/4"
d	3/8"	3/8"	3/8"	3/8"	3/8"	3/8"
e	2"	2"	2"	2"	2"	2"
f	2"	2"	2"	2"	2"	2"
l (mm)	485	725	565	645	765	765
m (mm)	1745	1725	2340	2370	2450	2950
Kit type included	C	C	C	C	Not included	
Weight (kg)	176	308	539	682	995	1160
Applicable directive	2014/68/EU (PED)					

### Vitroflex high pressure vessels

Capacity (L)	500	1000	2000	3000	4000	5000
Pressure (barg)	16	16	16	16	16	16
Diameter Ø	600	790	1000	1200	1430	1430
H tot (mm)	2120	2365	2810	2930	3110	3610
h (mm)	175	200	175	170	190	190
a	2"	2"	2"	2"	2"	2"
b	2"	2"	2"	2"	2"	2"
c	3/4"	3/4"	3/4"	3/4"	3/4"	3/4"
d	3/8"	3/8"	3/8"	3/8"	3/8"	3/8"
e	2"	2"	2"	2"	2"	2"
f	2"	2"	2"	2"	2"	2"
l (mm)	485	725	565	645	765	765
m (mm)	1745	1725	2340	2370	2450	2950
Kit type included	C	C	C	C	NotIncluded	
Weight (kg)	176	308	490	620	905	1055
Applicable directive	2014/68/EU (PED)					



## The importance of standards

Industry standards for air purity are important for everyone who uses compressed air. The quality of your compressed air has a considerable effect on the quality of your products as well as your operating costs. Contamination can cause maintenance costs, impact the life span of your components or even create health issues.



# Compressed Air Purity

Untreated compressor air always contains contaminants because of the nature of the gas and how it is produced. The ISO standards define a range of purity classes for particles, water and oil.

## Compressed air purity





At different points of use, different compressed air purities might be needed, depending on the application. ISO8573-1:2010 is the latest international standard for compressed air purity specification and defines purity classes for compressed air with respect to solid particles, water and oil.



The following tables specify which ISO8573-1:2010 purity classes are reached for certain combinations of Pneumatech dryers and filters. The applied color codes are explained in the general guidelines on the next page.



### Without Dryers

Product	Compressor
	
	Contaminant
Pneumatech reference	
	Oil-injected
	Oil-free without oil vapors at inlet



### With Refrigeration Dryer

Product	Compressor	Water separator	Coalescing filter – fine	Refrigeration dryer	Coalescing filter – super fine
					
Contaminant		Water aerosol	Oil aerosol & particles	Water vapor	Oil aerosol & particles
Pneumatech reference		SW	G	AC/AD/Cool	C
	Oil-injected	•	•	•	•
		•	•	•	•
		•	•	•	•
		•	•	•	•
	Oil-free without oil vapors at inlet	•	•	•	•
		•	•	•	•
	Oil-free with oil vapors at inlet	•	•	•	•
		•	•	•	•

Water separator	Coalescing filter – fine	Coalescing filter – super fine
		
Water aerosol	Oil aerosol & particles	Oil aerosol & particles
SW	G	C
•		
•	•	
•	•	•
•		
•	•	
•	•	•





ISO8573-1:2010 class		
		
Solid	Water	Total oil
–	–	–
2	–	3
1	–	2
–	–	0
2	–	0
1	–	0

Activated carbon tower	Dust filter – general protection	Dust filter – high efficiency
Oil vapor	Dry dust	Dry dust
VT/V	S	D
•	•	•
•	•	
•	•	•
•	•	

ISO8573-1:2010 class		
		
Solid	Water	Total oil
1	4	≤ 1
2	4	≤ 1
1	4	2
2	4	3
1	4	0
2	4	0
1	4	0
2	4	0

# Compressed air purity



## With Adsorption Dryer

	Compressor	Water separator	Coalescing filter – fine	Coalescing filter – super fine	Adsorption dryer
Product					
Contaminant		Water aerosol	Oil aerosol & particles	Oil aerosol & particles	Water vapor
Pneumatech reference		SW	G	C	PB/PE/PH
	Oil-injected	•	•	•	•
		•	•	•	•
		•	•	•	•
		•	•	•	•
	Oil-free without oil vapors at inlet	•		•	•
		•		•	•
		•		•	•
	Oil-free with oil vapors at inlet	•		•	•
		•		•	•
		•		•	•

### General guidelines

- You always need to install a water separating device in front of a coalescing filter. This can be either a freestanding version (SW) or an integrated water separating device in the after cooler.
- You always need to install a dryer in front of an oil vapor removal filter (VT/V).
- It is recommended to install a G coalescence filter in front of a free-standing refrigeration dryer.
- It is recommended to install a G - C combination in front of an adsorption dryer, in case of oil-injected compressors.
- It is recommended to install an additional P pre-filter upstream the G filter in case of heavy contamination.
- In case of critical applications, it is better to install air treatment products at point of use, in order to make sure that pipeline contamination is removed.

Activated carbon tower	Dust filter – general protection	Dust filter – high efficiency
Oil vapor	Dry dust	Dry dust
VT/V	S	D
•	•	•
•	•	
	•	
	•	•
	•	
•	•	•
•	•	
•		

ISO8573-1:2010 class		
		
Solid	Water	Total oil
1	1-3	≤ 1
2	1-3	≤ 1
2	1-3	2
–	1-3	2
1	1-3	0
2	1-3	0
–	1-3	0
1	1-3	0
2	1-3	0
–	1-3	0

### ISO8573-1:2010 purity classes

Purity Class	Solid particles			Water		Total Oil*
	Number of particles per m <sup>3</sup>			Pressure dewpoint		Concentration
	0.1 < d ≤ 0.5 μm**	0.5 < d ≤ 1.0 μm**	1.0 < d ≤ 5.0 μm**	°C	°F	mg/m <sup>3</sup>
0	As specified by the equipment user or supplier and more stringent than Class 1.					
1	≤ 20.000	≤ 400	≤ 10	≤ -70	≤ -94	≤ 0.01
2	≤ 400.000	≤ 6.000	≤ 100	≤ -40	≤ -40	≤ 0.1
3	–	≤ 90.000	≤ 1.000	≤ -20	≤ -4	≤ 1
4	–	–	≤ 10.000	≤ 3	≤ 37.4	≤ 5
5	–	–	≤ 100.000	≤ 7	≤ 44.6	–
6	≤ 5 mg/m <sup>3</sup>			≤ 10	≤ 50	–

\* Liquid, aerosol and vapor\*\* d= diameter of the particle



Pneumatech reserves the right to change or revise specifications and product design in connection with any features of our products. Such changes do not entitle the buyer to corresponding changes, improvements, additions or replacements for equipment previously sold or shipped.

© 2020 Pneumatech. All rights reserved.

